

INSTRUCTION MANUAL

T154

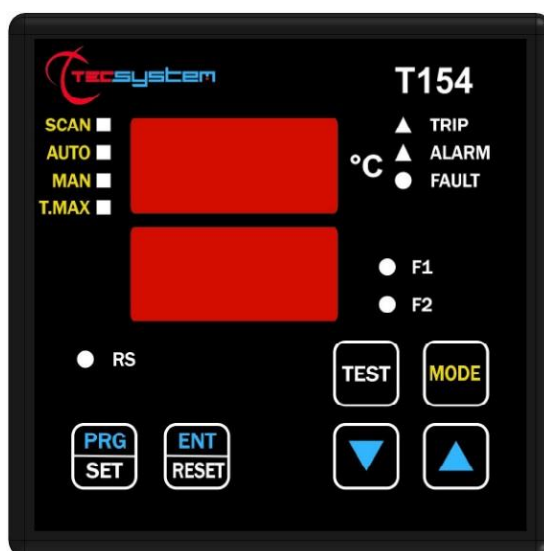

1MN0101 REV. 0



operates with ISO9001 certified quality system

TECSYSTEM S.r.l.
20094 Corsico (MI)
Tel.: +39-024581861
Fax: +39-0248600783

<http://www.tecsystem.it>

R. 1.6 06/09/17

ENGLISH

“Translations of the original instructions”

INTRODUCTION

First of all we wish to thank you for choosing to use a **TECSYSTEM** product and recommend you read this instruction manual carefully: You will understand the use of the equipment and therefore be able to take advantage of all its functions.

ATTENTION! THIS MANUAL IS VALID AND COMPLETE FOR THE CONTROL UNIT T154

CONTENTS

	PAGE
1) SAFETY REQUIREMENTS	3
2) ACCESSORIES	4
3) TECHNICAL SPECIFICATIONS	5
4) FRONT PANEL	7
• DISPLAY	8
• OPERATING PROGRAM CONTROL	—
• NOTES ON SCAN AND MAN FUNCTIONS	—
• LED TEST	—
• ALARM RELAY TEST	—
• ALARM RELAY SILENCING	—
5) MOUNTING	9
6) ELECTRICAL CONNECTIONS	10
• ELECTRICAL CONNECTIONS T154	—
• POWER SUPPLY	11
• ALARMS AND VENTILATION	—
• FAULT AND RESET MESSAGE SEQUENCE	—
7) PROGRAMMING	12
• PROGRAMMING T154	—
• TEMPERATURE SENSORS	14
• MEASUREMENT SIGNAL TRANSFER	—
• TEMPERATURE SENSOR DIAGNOSTICS	15
• PROGRAMMED DATA DIAGNOSTICS	—
• TEMPERATURE DIAGNOSTICS	—
• COOLING FAN CONTROL	—
• FAN TEST	—
8) TECHNICAL SPECIFICATIONS OF THE EXTENSION CABLE FOR Pt100	16
9) FCD FUNCTION	—
10) WARRANTY CONDITIONS	17
11) TROUBLESHOOTING	—
12) EQUIPMENT DISPOSAL	—
13) FAILSAFE FUNCTION	18
14) USEFUL CONTACTS	—
15) UL SPECIFICATION AND RATINGS	—
16) C01 T154 -V- ED16 CHANGES VERSION	19

SAFETY REQUIREMENTS



ATTENTION :

Read the manual carefully before starting to use the control unit. Keep the instructions for future reference.



Do not open the device, touching any internal components can cause electric shock. Contact with voltage over 50 Volts can be fatal. To reduce the risk of electric shock, do not dismantle the back of the device for any reason. Moreover its opening would void the warranty.

Before connecting the device to the power supply, make sure that all the connections are correct. Always disconnect the unit from the supply before any cabling modification.



Any work on the equipment must be entrusted to a qualified engineer.

Failure to comply with these instructions can cause damages, fires or electric shock, and possible serious injuries!

POWER SUPPLY

The series T154 ED16 has UNIVERSAL power supply, i.e. it can be supplied by 24 to 240 Vac-Vdc, irrespectively of polarity in Vdc. Before using it, make sure the power cable is not damaged, knotted or pinched. Do not tamper with the power cable. Never disconnect the unit by pulling the cable, avoid touching the pins. Do not carry out any connecting/disconnecting with wet hands. To disconnect the device, do not use objects such as levers. Immediately disconnect the device if you smell burning or see any smoke: contact technical service.

LIQUIDS

Do not expose the equipment to splashes or drops, do not position it in places with humidity exceeding 90% and never touch with wet or humid hands during storms. If any liquid penetrates the control unit, disconnect it immediately and contact technical service.

CLEANING

Disconnect the power cable before cleaning the control unit, use a dry cloth to dust it, without any solvent or detergents, and compressed air.

OBJECTS

Never insert any objects into the cracks of the control unit. If this happens, disconnect the control unit and contact an engineer.

USE RESERVED TO QUALIFIED PERSONNEL

The purchased goods are a sophisticated electronic device that is totally unsuitable to be used by non-qualified personnel. Any work must be carried out by a specialist engineer.

ACCESSORIES

The use of non-original accessories or spare parts can damage the unit and endanger users' safety. In the event of faults, contact technical service.

LOCATION

Install the control unit indoors, in a place protected from water splashes and sun rays. Do not place near heat sources exceeding the parameters stated in this manual. Position on a stable surface, far from any possible vibrations. Position the unit as far as possible from any intense magnetic fields.

REPAIRS

Do not open the control unit. For any fault, always use qualified personnel. The opening of the control unit and/or the removal of the series identifying label entails the automatic forfeiture of the warranty. The Warranty seal is applied to all devices, any attempt to open the unit would break the seal and cause the consequent automatic forfeiture of the warranty.

FUNCTION

To control the transformer correctly from a temperature point of view, enabling the VOTING function is allowed where the load distributed between the phases of the transformer is adequately balanced.

TECHNICAL INFORMATION

Mail: ufficiotecnico@tecsystem.it — tel: 02/4581861

ACCESSORIES

The following objects are present inside the box:

Control unit



Quick Guide and QR code



2 blocks for panel mounting

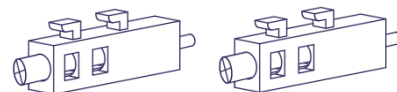

1 supply terminal 3 poles pitch 5
Code: 2PL0367- Screws tightening torque 0.5Nm



1 relay terminal 10 poles pitch 5
Code: 2PL0394 -Screws tightening torque 0.5Nm



1 Pt100 sensor terminal 12 poles pitch 3.81
Code: 2PL0420- Screws tightening torque 0,25Nm



1MN0030 REV. 2

ATTENTION: always install the device using the terminals included in the pack. The use of terminals other than those included with the control unit might cause malfunctions.

TECHNICAL SPECIFICATIONS	T154
POWER SUPPLY	
Supply rated values	24-240 Vac-Vdc 50/60Hz
Maximum and minimum supply values	20-270 Vac-Vdc 50/60Hz
Vdc with reversible polarities	●
INPUTS	
4 inputs for RTD sensors, Pt100 type with 3 wires (max section 1.5mm ²)	●
Connections on removable terminal strips	●
Input channels protected against electromagnetic interference	●
Cable compensation for thermistors	500 m (1 mm ²)
OUTPUTS	
2 alarm relays (ALARM AND TRIP) SPDT	●
1 sensor or operating failure (FAULT) relay SPST	●
1 ventilation management relays SPST FAN 1	●
Output relay with 10A-250Vac-res COS Φ =1 contacts.	●
DIMENSIONS	
100x100 mm– din43700-depth 131mm (terminal block included)	Hole 92 x 92 mm
TESTS AND PERFORMANCE	
Construction in compliance with CE regulations	●
Protection from electrical interference EN 61000-4-4	●
Dielectric strength 1500 Vac for a min. between output relays and sensors, relays and power supply, power supply and sensors	●
Accuracy $\pm 1\%$ full scale value, ± 1 digit	●
Ambient operating temperature from -20°C to $+60^{\circ}\text{C}$	●
Humidity 90% non-condensing	●

TECHNICAL SPECIFICATIONS	T154
TESTS AND PERFORMANCE	
Frontal film polycarbonate IP65	•
Housing NORYL 94_V0	•
Absorption 7,5VA	•
Data memory 10 years minimum	•
Digital linearity of sensor signal	•
Self-diagnostic circuit	•
Protection treatment of the electronic part	Option
DISPLAY AND DATA MANAGEMENT	
2x13mm displays with 3 digits to display temperatures, messages and channels	•
3 LEDs to display the state of the alarms of the selected channel (ALARM-TRIP-FAULT)	•
4 leds selection of display mode (SCAN-AUTO-MAN-T-MAX)	•
1 LEDs to display the state of FAN1	•
Temperature control from 0°C ÷ to 240°C	•
2 alarm thresholds for channels 1-2-3	•
2 alarm thresholds for channel 4	•
1 ventilation ON-OFF thresholds FAN 1	•
Sensor diagnostics (Fcc-Foc-Fcd)	•
Data memory diagnostics (Ech)	•
Access to programming through front keyboard	•
Automatic exit from relay programming, display and test after 1 minute's inactivity	•
Incorrect programming warning	•
Selection between channel automatic scanning, hottest channel or manual scanning	•
Storage of maximum temperatures reached by channels and alarm status	•
Front key to reset the alarms	•
Failsafe function	•

FRONT PANEL

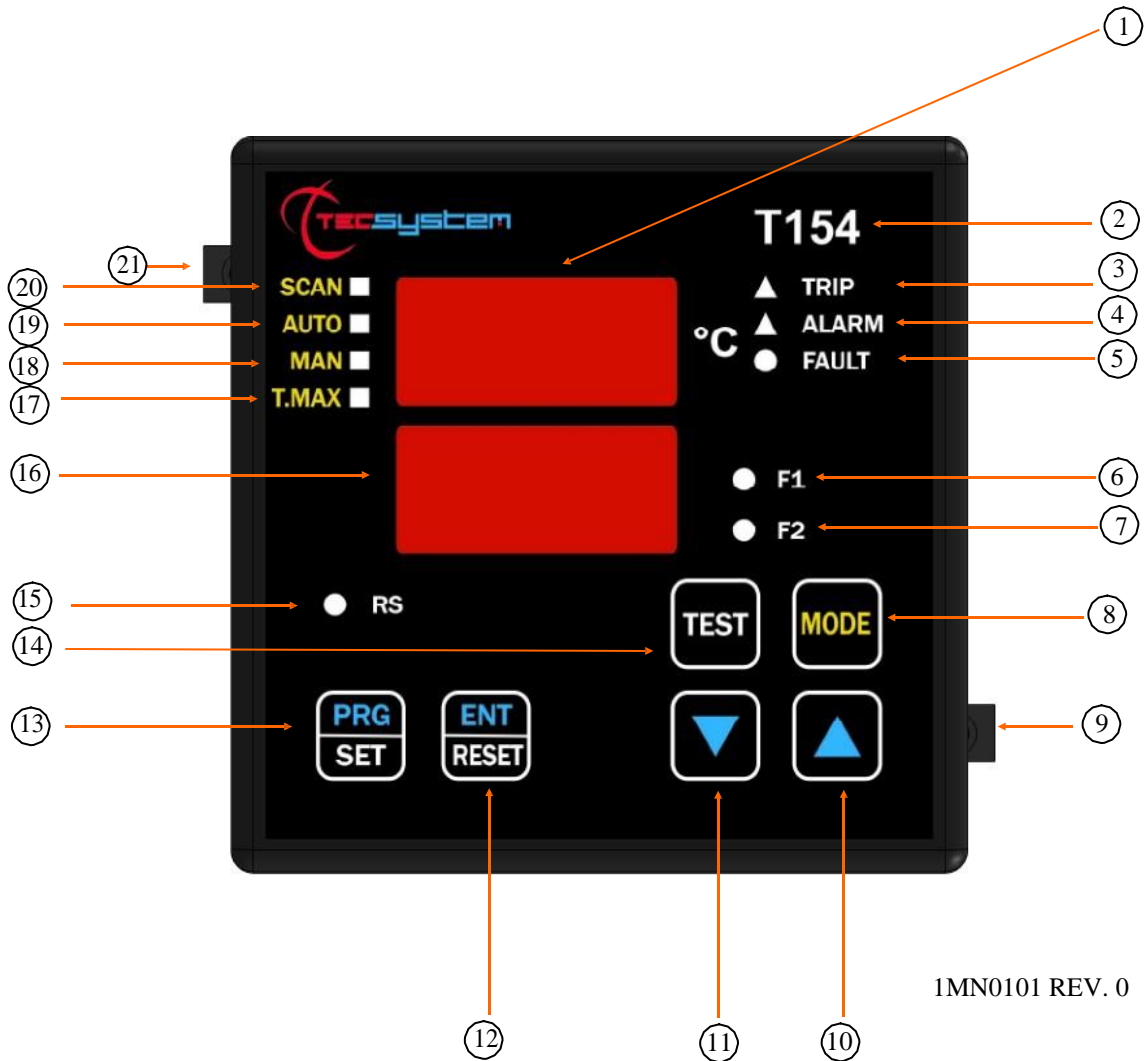

1MN0101 REV. 0

1)	3-digit temperature display	12)	Enter/Reset button
2)	Control unit series	13)	Programming / Setting button
3)	TRIP (red) LED	14)	LED/relay test button
4)	ALARM (yellow) LED	15)	RS (green) LED (not used)
5)	FAULT (red) LED	16)	3-digit channel display
6)	FAN 1 (yellow) LED	17)	T-max mode selection (red) LED
7)	FAN 2 (yellow) LED (not used)	18)	Man mode selection (yellow) LED
8)	Display mode selection button	19)	Auto mode selection (green) LED
9)	Fixing block	20)	Scan mode selection (yellow) LED
10)	UP key	21)	Fixing block
11)	DOWN key		

DISPLAY

The first display is dedicated to the visualisation of temperatures.

The second display is dedicated to the visualisation of the monitored channel.

When the device is switched on or following a reset, the display shows: the control unit model, T154 (BAS no options, C01 T154-V-) with VER "00" (firmware version) and temperature range of the unit.

Pressing MODE key, the display mode is loaded:

- **SCAN:** the monitoring unit displays all the activated (°C) and deactivated (NO) channels scanning every 2 seconds.
- **AUTO:** the monitoring unit displays the hottest channel automatically.
- **MAN:** manual reading of the channel temperature using the up/down keys ▲▼.
- **T.MAX:** the monitoring unit displays the highest temperature reached by the sensors and any situation of alarm or fault occurred, after the last reset. Select channels with cursors ▲▼, reset values with RESET.

OPERATING PROGRAM CONTROL

To control the protection levels programmed, press the PRG button twice to access the **VIS** display mode. By repeatedly pressing the PRG button, you can scroll through all the previously loaded values in sequence. After 1 minute's keyboard inactivity, the programming display procedure is automatically abandoned.

To stop the display, press the ENT button.

NOTES ON SCAN AND MAN FUNCTIONS

During the SCAN and MAN modes, the operation of the T154 can be displayed.

- 1) RUN CPU:** This message appears when the unit operates regularly without any system error.
- 2) Ech Err:** This message appears when a damage in the EEPROM memory is detected. Pressing Reset will cancel the message and restore the original default parameters, listed in the programming paragraph on page 12. Return the control unit to TECSYSTEM for repairs.
- 3) CAL Err:** This message appears when damage is found in the measurement circuit. The temperature values displayed might be incorrect. Return the control unit to TECSYSTEM for repairs.
- 4) Pt Err:** This message appears when it is detected that one or more PT100 sensors are not working correctly, FOC, FCC and FCD indications in the temperature sensor diagnostics paragraph on page 15. In case of **Err** the FAULT relay will be de-energised.

The above messages will be displayed following the 1-2-3-4 priority stated.

NOTE: regardless of the display mode, in case of a sensor fault (fcc, foc or fcd), the control unit will automatically switch to **SCAN (PRIVILEGED SCAN) mode**, immediately allowing you to see the fault on the relative channel **CH (Mode key is disabled)**.

LED TEST

We suggest carrying out the control unit LED test regularly.

For this operation, press the TEST key briefly; all the displays turn on for 2 seconds.

If one of the LEDS does not work, please return the control unit to TECSYSTEM for repair.

ALARM RELAY TEST

This function allows carrying out a test of the relay operation without having to use any other devices.

To start the test procedure, keep the TEST button pressed for about 5 seconds: TST appears for 2 seconds, confirming you have entered Relay Test mode.

The LED that is lit shows the relay to be tested; use the cursors ▲▼ to select the desired relay.

Press the SET and RESET keys to energise and de-energise the relay to be tested; the display will show ON- OFF.

After 1 minute's keyboard inactivity, the RELAY TEST procedure will be automatically abandoned. To stop the RELAY TEST procedure, press the TEST key.

Alternatively, you can use the PT100 simulator model: SIM PT100.

ALARM RELAY SILENCING

If you want to silence the ALARM signal, press the RESET key: the relay de-energises and the ALARM LED, which was fixed, will start flashing.

Silencing is automatically disabled when the temperature goes below the ALARM threshold.

MOUNTING

Drill a 92 x 92 mm hole in the panel sheet.

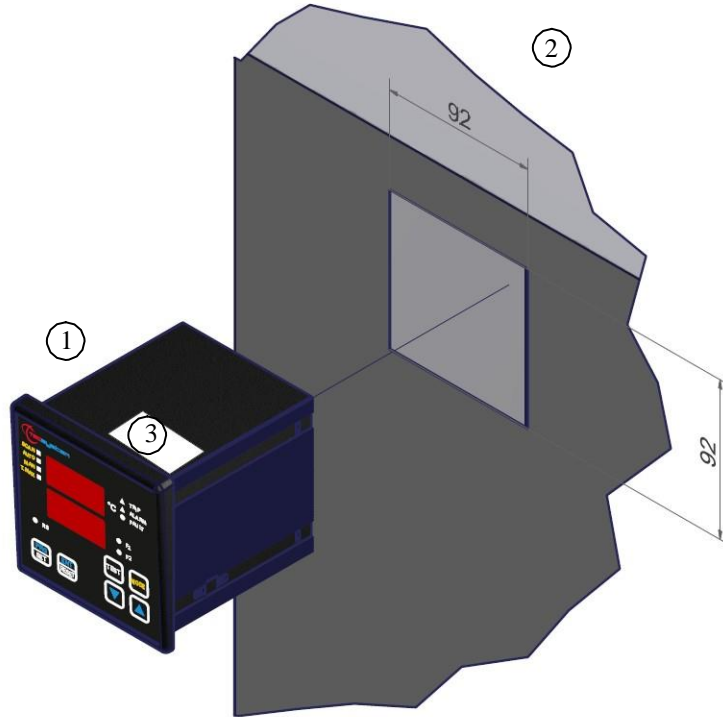

1MN0007 REV. 0

1)	Control unit	2)	Panel hole dimensions (+0.8mm tolerance)
3)	Identification label		

Fix the unit securely with the blocks supplied.

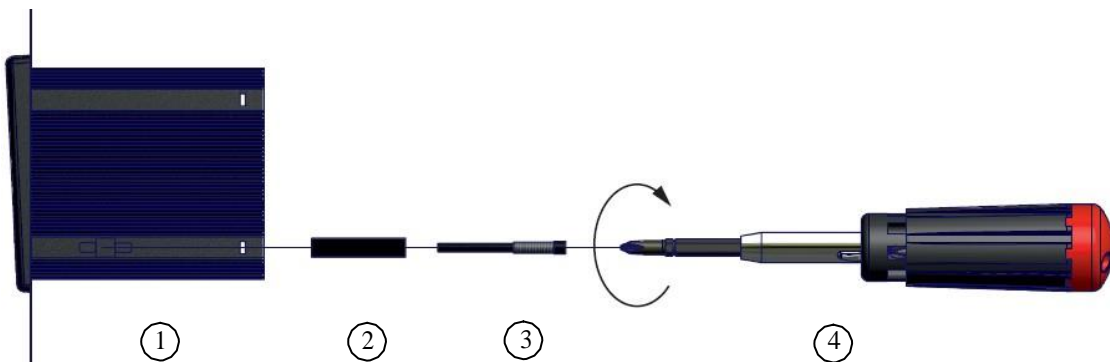

1MN0008 REV.0

1)	Control unit	3)	Fixing screw
2)	Fixing block	4)	Crosshead screwdriver #1X100mm

ELECTRICAL CONNECTIONS

T154

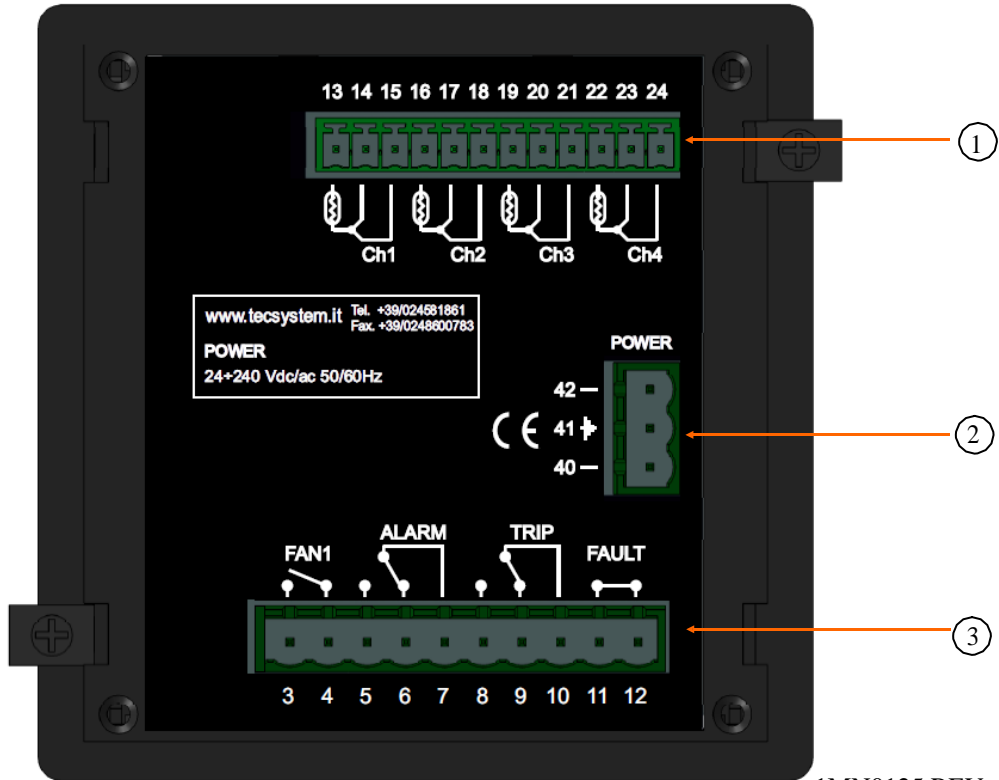

1)	Pt100 sensors (white-red-red)	3)	Relays (FAN1-ALARM-TRIP-FAULT)
2)	Supply 24-240Vac-dc 50/60Hz.		

Note: relay contact image in non-alarm condition, with the exception of the FAULT relay that switches: contact 11-12 open (NO), contacts 11-12 closed (NC) fault condition identification. Read the Alarms and Ventilation paragraph on page 11 and see the fault contact switching.

RELAY CONNECTION EXAMPLE

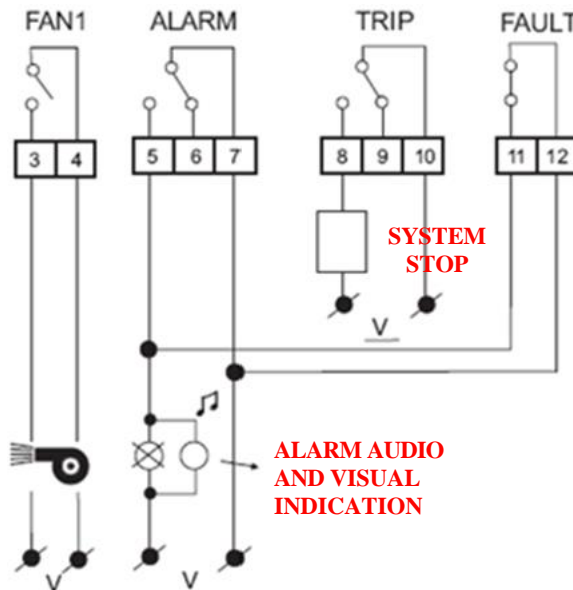

Pt100 CONNECTION EXAMPLE

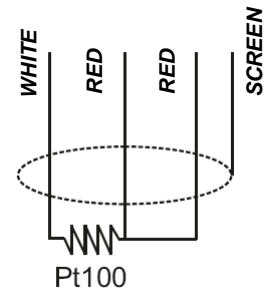

! Note: Before connecting the sensors to the control unit, read the Measurement signal transfer paragraph on page 14 carefully.

Output relay with 10A-250Vac-res COS Φ =1 contacts

POWER SUPPLY

The T54 ED16 series has UNIVERSAL power supply, i.e. it can be supplied by 24 to 240 Vac-Vdc, 50/60Hz irrespectively of polarity in Vdc (terminals 40-42).

This is obtained thanks to the use of a tested power supply unit, newly designed and manufactured, that frees installers from worrying about the correct Vac and Vdc supply.

The ground must always be connected to terminal 41.

When the unit is supplied directly by the secondary of the transformer to protect, it can be burnt out by strong overvoltages. This happens if the main switch is closed and the transformer has no load (blank test). The above-mentioned problems are much more evident when the 220 Vac voltage is taken directly from the transformer secondary bars and there is a fixed capacitor battery to phase the transformer itself.

To protect the monitoring device from line overvoltages, we suggest you use the PT-73- 220 electronic discharger, designed by TECSYSTEM S.r.l. for this specific purpose. As an alternative we suggest using 110 Vac or, even better, 110 Vdc supply voltages.

If an existing control unit must be replaced with a new one, to guarantee its correct and safe operation, the sensor/relay/supply connecting terminals must be replaced with the new terminals supplied.

ALARMS AND VENTILATION

Carry out the electrical connections on the removable terminal blocks only after disconnecting them from the unit. When the control unit is in one of the modes mentioned below, it does not monitor the temperature and the relays are all blocked. The fault contact switches and the fault LED flashes.

- Vis. programming display
- PRG programming
- Relay test

The ALARM and TRIP relays switch only when the set temperature thresholds are exceeded.

The FAULT contact, programmed in failsafe mode (default YES), switches when the equipment is powered only if the unit detects no fault on start up, and stays in this condition until one of the following events occurs:

- Data storage fault (Ech message).
- Pt100 sensor fault (FCC short-circuited sensor, FOC interrupted sensor or Fcd quick temperature increase)
- CAL damage to the measurement circuit.
- Insufficient supply voltage.
- During the power on reset after programming (PRG), displaying the data (VIS) and Test relay.

The FAULT failsafe can be disabled selecting FAULT failsafe "NO" see step 26-31 programming page 13.

NOTE: do not connect the FAULT relay to the transformer tripping circuit to avoid unwanted system interruptions.

FAULT CONTACT SWITCHING (failsafe enabled)

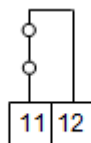

FAULT 11-12 NC: ALARM FAULT OR POWER OFF

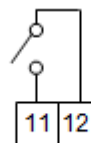

FAULT 11-12 NO: POWER ON OR NO FAULT

The FAN1 contact can be used to control the cooling fans, or it can be included in the conditioning system of the transformer room, see paragraph Fan control on page 15.

NOTE: always disconnect the unit before performing any electrical connections.

FAULT AND RESET MESSAGE SEQUENCE





















Find below the sequence of fault messages and RESET function condition.

1) ECH	Eeprom fault	erasable message
2) CAL	Measurement circuit fault	erasable message
3) FCD	Temp. quick increase fault	resettable condition
4) ERR PT	FOC or FCC sensor fault	non- resettable condition

PROGRAMMING

T154

STEP	PRESS	EFFECT	PRESS	NOTES
1		Keep the PRG key pressed until the display shows PRG SET		
2		Select PRG SET for entering in the programming mode or PRG 1 to restore the default programmed value.	 	PRG 1 default value
3		The ALARM threshold for (CH 1 - 2 -3) is displayed Set the desired threshold, the Alarm LED flashes	 	Default 90°C
4		The TRIP threshold for (CH 1-2-3) is displayed and the Trip LED flashes.		
5		Set the desired threshold	 	Default 119°C
6		1.2.3 is displayed the Fan1 LED flashes.		
7		Select YES or NO	 	Default YES
8		The display shows (CH4) CH4 enabling		
9		Set YES or NO	 	with YES CH4 is enabled, with NO CH4 is disabled.
10		The ALARM threshold for (CH4) is displayed, the Alarm LED flashes.		If CH4=NO go to step 16, Default NO
11		Set the desired threshold	 	Default 120°C
12		The TRIP threshold for (CH4) is displayed and the Trip LED flashes.		
13		Set the desired threshold	 	Default 140°C
14		CH4 is displayed the Fan1 LED flashes.		IF CH1.2.3 enabled CH4=NO it can't be enabled
15		Set YES or NO	 	Default NO
16		FAN ON is displayed the FAN1 LED flashes.		If FAN1=NO go to step 20
17		Set the desired FAN1 ON threshold	 	Default 70°C
18		FAN OFF is displayed, the FAN1 LED flashes		
19		Set the desired FAN1 OFF threshold	 	Default 60°C

20		HFN (NO) is displayed The FAN1 LEDs flashes		Cyclical test of the fans for 5 minutes every "n" hours
21		Set the desired number of hours	 	Default NO = function disabled
22		FCD (NO) is displayed		Fault due to quick temperature increase (°C/sec)
23		Set the desired value (FCD page 16)	 	Default "no" (function excluded)
		for version T154 (BAS) jump to the step 26		
24		VOT (YES) is displayed (See VOTING on page 19)		C01 T154 -V-
25		Set YES or NO	 	Default YES solo per C01 T154 -V- (function enable)
26		The display shows FLS (ALARM) flashing LED ALARM (info FAIL SAFE on page 18)		
27		Set YES or NO	 	Default NO
28		The display shows FLS (TRIP) LED flashes TRIP		
29		Set YES or NO	 	Default NO
30		The display shows FLS (FAULT) LED flashes FAULT		
31		Set YES or NO	 	Default YES
32		END is displayed		End of programming
33		Press ENT to store the settings and exit programming		Err: incorrect programming of the LED values (note 6)
34		Return to step 1		

- 1) The **MODE** key allows reversing the programming steps according to the sequence 26-23-8-1.
- 2) The **TEST** key allows exiting programming without saving the modified data.
- 3) After 1 minute's keyboard inactivity, programming is exited without saving the data.
- 4) During programming the control unit does not control/protect the monitored machine.
- 5) At the end of programming the control unit is restarted and the **FAULT** relay is disabled until the unit is fully restarted.
- 6) If pressing **ENT**, "Err" appears, it means that one of the following mistakes has been made:

ERR ALL. = ALARM ≥ TRIP
ERR FAN = FAN-OFF ≥ FAN-ON. (FAN1)

The device automatically switches to the programming step of the mistake.

NOTE: EVERY TIME THE CONTROL UNIT IS PROGRAMMED WITH DATA SAVING CONFIRMATION, THE VALUES STORED IN T-MAX ARE RESET TO THE TIME OF SAVING.



ATTENTION :

We recommend you check the unit's programming before starting the device.

The default parameters set by TECSYSTEM might not match your requirements.

Programming the device is the end user's responsibility, the settings of the alarm thresholds and the enabling of the functions described in this manual must be checked (by a specialized engineer) according to the application and features of the system where the control unit is installed.

TEMPERATURE SENSORS

Each Pt100 thermometric sensor has one white and two red wires (CEI 75.8 regulations).

The CH2 channel must be always referred to the central column of the transformer.

The CH4 channel must be always referred either to the core of the transformer or to the Pt100 ambient sensor, if you wish to thermo-regulate the transformer room using the T154 control unit.

MEASUREMENT SIGNAL TRANSFER

All the cables transferring the Pt100 measurement signals must comply with the following under all circumstances:

1. Every Pt100 must be connected with a three-wire cable having a minimum section of 0.35mm² and a maximum of 1 mm².
2. The extension cable must be screened with a tinned copper braid with 80% cover.
3. Conductors must be twisted, maximum recommended step 60mm.
4. The cable screening must be grounded only with a termination, preferably on the unit side.
5. The sensors' signal transfer cable must not be near any electrical cables, either low or medium-high voltage.
6. The Pt100 cable and the signal transfer cable must be laid in a straight line, without any winding.
7. Any caps used to butt conductors must be crimped properly to avoid false contacts.

NOTE: to install the sensors and signal transferring cable correctly, read the SCS / SENSOR installation rules manual.

What may happen when installation rules are not complied with.

- 1) The electrical field propagating from the power line of another circuit, couples capacitively with the conductors (in particular with unshielded cables). The effect of this coupling creates a signal that overlaps the signal transmitted by the nearby conductors, causing incorrect readings.
- 2) The variations in magnetic flux in the power lines may induce an electromotive force on the signal transferring cables (in particular non-twisted cables), that, being a closed circuit, generates a current. This interference current, multiplied by the circuit resistance, gives a voltage value that overlaps the signal to be transmitted, distorting the sensor measurement.
- 3) False contacts can alter the signal with the consequent variation in the temperature detected.

In specific cases, when the rules for connecting the Pt100 sensors are not complied with, the following anomalies can occur between the SCS box and the temperature control unit:

- a) **incorrect temperature readings, alarms or anomalous tripping**
- b) **mechanical / electrical fault of the Pt100 sensors**
- c) **damage to the Pt100 inputs of the control unit.**

TECSYSTEM S.r.l. has designed its own special cable to transfer the measurement signals, CEI-compliant, with all the protection requirements provided for: model CT-ES

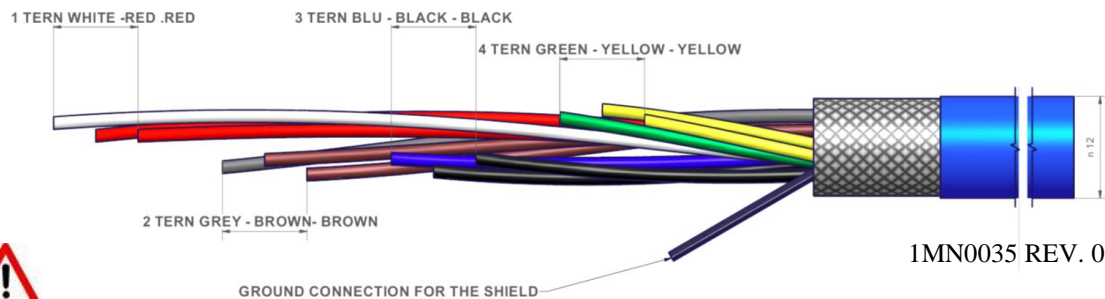

ATTENTION: the use of cables not complying with the above might cause reading anomalies. It is always important to take into account that any interference on the signal lines might cause anomalies on the Pt100 inputs (CH1-CH2-CH3-CH4...) or the sensors

All T series control units have linearity of the sensor signal, with a maximum error of 1% of full scale value.

TEMPERATURE SENSOR DIAGNOSTICS

In case of failure or exceeded minimum/maximum full scale value of one of the thermometric sensors installed on the machine to protect, the **FAULT** relay switches immediately with the relative warning of faulty sensor on the corresponding channel (**Pt Err**) :

Fcc indicates sensor short-circuited or minimum full scale value of the control unit exceeded -8°C

Foc indicates sensor interrupted or maximum full scale value of the control unit exceeded 243°C

To eliminate the message and reset **FAULT** switching, it is necessary to check the Pt100 connections and replace the faulty sensor (if any). If the minimum/maximum full scale value has been reached, check that the ambient conditions match the control unit reading.

Note: exceeding the maximum/minimum full scale value may be caused also by possible interference on the sensor lines, in this case we recommend you to check the sensors and the extension cable in particular are installed correctly (as stated in the MEASUREMENT SIGNAL TRANSFER paragraph on page 15).

We recommend you to enable the FCD (on page 16) function, only after carefully assessing the system conditions.

CAL message display: it appears when damage is found in the measurement circuit. The temperature values displayed might be incorrect. Return the control unit to TECSYSTEM for repairs

PROGRAMMED DATA DIAGNOSTICS

In case of failure of the internal memory or alteration of the programmed data, at start-up **Ech** is displayed with the relative warning of the Fault contact.

In this case, for safety reasons, the default parameters are loaded automatically (see programming table on pages 13-16).

Eliminate **Ech** by pressing **RESET** and run programming to enter the desired values.

Finally switch the unit off and back on to check the memory works correctly, if it is damaged **Ech** will be displayed again (send the control unit to TECSYSTEM srl for repairs).

TEMPERATURE DIAGNOSTICS

When one of the temperature sensors senses a temperature 1°C higher than the alarm threshold, 5 seconds later the **ALARM** relay switches and the **ALARM** LED of the affected channel (**CHn**) lights up.

When the trip temperature threshold is exceeded, the **TRIP** relay switches and the **TRIP** LED of the interested channel (**CHn**) lights up. As soon as the temperature goes back to values equal to or lower than the threshold set for the **ALARM** and **TRIP** relays, these relays deenergise and the relative LEDs switch off.

The **ALARM** and **TRIP** values are kept in the internal memory: they can be recalled by entering the **Vis** mode (programmed parameter display) and modified in **PRG** (programming) mode.

COOLING FAN CONTROL

The T154 control unit is fitted with one **FAN** contacts (**FAN1**), if programmed correctly, can control the fans switching **ON** and **OFF** to cool the transformer.

The **FAN1** contact can manage cooling the transformer or the room where it is installed.

The fans can be controlled in two different ways:

- Using the temperatures sensed by the sensors on the three columns **CHF 1.2.3**
(ex. **ON** at 70°C - **OFF** at 60°C)
- With an extra sensor (**CH4/YES**) dedicated to the ambient temperature inside the transformer room **CHF 4**
(ex. **ON** at 45°C - **OFF** at 35°C)

The **ON** and **OFF** values are programmable according to the device range. **FAN ON** must always be greater by at least 1 ° C since **FAN OFF** (recommended Δ **FAN POWER ON-OFF** + 10°C).

The **FAN 1** LED lights up when the temperature exceeds 1°C the **FAN ON** threshold, the corresponding relay switches, and turns off when the temperature goes below 1°C the **FAN OFF** threshold, the corresponding relay switches.

FAN TEST

By programming (**HF_n**), it is possible to have the fans operating 5 minutes every "xxx" hours, regardless of the column or ambient temperature values (i.e.: with **HF_n**=001 the fans are activated for 5 minutes every hour).

This function aims at verifying the fan operation and their control apparatus periodically.

By setting **NO** this function is inhibited.

To enable the **Hfn** function, read the programming section on pages 12-13.

IMPORTANT WARNING



Before carrying out the isolation test of the electrical panel the control unit is installed on, disconnect it together with the sensors from the power supply, to prevent it from being seriously damaged.

TECHNICAL SPECIFICATIONS OF Pt100 EXTENSION CABLE

1. Cable 20 x AWG 20/19 Cu/Sn
2. Section 0.55 mm²
3. Flame retardant insulation PVC105
4. CEI 20.35 IEC 332.1 regulations
5. Maximum operating temperature: 90°C
6. Conformation: 4 sets of three twisted and coloured conductors
7. Shield in Cu/Sn
8. Flame retardant PVC sheath
9. External diameter 12mm
10. Standard conformation in 100m coils

FCD FUNCTION

The T series equipment boasts an innovative control function combined with the dynamic status of the Pt100 sensor.

Activating FCD, the control unit analyses the increase in temperature ΔT (*) recorded in a second (**°C/sec**).

Enabling the function, the user can select the value (ΔT) from a minimum of 1°C/sec to a maximum of 30°C/ sec. If the value sensed is higher than the value set by the user, the control unit inhibits the possible activation of the ALARM and TRIP alarms and switches the FAULT relay (11-12), displaying the message "**Fcd fault**".

Example: if we set the function to 5°C, FAULT will switch for FCD only if the control unit senses an increase in ΔT of over 5°C in a second on the monitored system.

Setting "no" disables the FCD function.

When a channel is in FAULT for FCD, the relative Alarm and Trip warnings are inhibited on the single channel; therefore only the over-quick temperature increase is highlighted.

Press Reset to delete the FCD warnings on all channels and reset the FAULT relay.

Possible FCD applications

Identification of a possible induced interference on the Pt100 sensor line

If the installation instructions are not complied with (see page 14), any disturbance on the Pt100 sensor line can cause false readings or anomalous alarms.

Setting the FCD function in a temperature range of between 1°C and 10°C (5°C recommended), the effects caused by false readings can be suppressed and the alarm relay activation can be prevented, as shown above.

Corrective actions: check the installation of the sensor extension cable is in line with the instructions given in the paragraph on the measurement signal transfer on page 14.

Identification of a sensor fault or faulty connection

In case of a faulty connection or sensor fault, a quick positive or negative variation in temperature might occur, leading to the system tripping or the alarms of the monitored system to be triggered.

In this specific case we recommend the FCD function to be set in a temperature range of between 10°C and 20°C.

Corrective actions: check the terminals the sensor is connected to are tightened and replace the faulty sensor, if required.

Identification of the electrical motor rotor block

In case of temperature control of the electrical motors, the quick temperature increase might be due to a blocked rotor.

In this specific case we recommend the FCD function to be set in a temperature range of between 20°C and 30°C. This setting is recommended in order to prevent the FCD function from activating during motor startup, or where the ΔT /sec. increase varies quickly.

(*) The ΔT value shows the temperature range for each second

WARRANTY CONDITIONS

The Product purchased is covered by the manufacturer's or seller's warranty at the terms and conditions set forth in the "Tecsystem s.r.l.'s General Conditions of Sale", available at www.tecssystem.it and / or in the purchase agreement.

The warranty is considered valid only when the product is damaged by causes attributable to TECSYSTEM srl, such as manufacturing or components defects.

The warranty is invalid if the Product proves to have been tampered with / modified, incorrectly connected, because of voltages outside the limits, non-compliance with the assembly and use technical data, as described in this instruction manual.

The warranty is always ex Corsico as stated in the "General Conditions of Sale".

TROUBLESHOOTING	CAUSES AND SOLUTIONS
The control unit does not switch on and the supply to terminals 40-42 is correct.	Check that: the connector is correctly inserted into its housing, the wires are tightened, there is no evidence of burning on the connectors. Disconnect the power supply, carry out the above and reconnect.
CH4 is in FAULT because of FOC (only the 3 Pt100 sensors are connected)	Programming error of the CH4 / YES control unit. <i>Check and repeat programming as per page 12-13, select CH4 / NO.</i>
One of the three/four channels is in FAULT due to FOC/FCC	Check the connections of the Pt100 sensors, check the instructions given in the paragraphs: <i>measurement signal transfer and temperature sensor diagnostics on page 14-15.</i>
When turning on, the display shows "ECH"	Strong interference has damaged the stored data. See the paragraph Programmed data diagnostics on page 15.
All the PT100 sensors are in FCC.	Incorrect sensor connection, the terminal block has been inserted upside down. <i>Check the connections and the terminal board.</i>
The temperature shown by one or more channels is wrong.	Contact the <i>TECSYSTEM Technical Department.</i>
Sudden trip of the main switch. The temperature is on standard levels. Just one channel has caused the trip.	Check the temperatures recorded in T-MAX, check the instructions given in the paragraphs: <i>measurement signal transfer and temperature sensor diagnostics on pages 14-15. Activate the FCD function.</i>
FCD warning	See the FCD function on page 16.
Contact <i>TECSYSTEM Technical Department</i> if the problem persists.	

EQUIPMENT DISPOSAL

European directives 2012/19/EC (WEEE) and 2011/65/EC (RoHS) have been approved to reduce electrical and electronic waste and promote the recycling and reuse of the materials and components of said equipment, cutting down on the disposal of the residues and harmful components of electrical and electronic materials.



All the electrical and electronic equipment supplied after 13 August 2005 is marked with this symbol, pursuant to European directive 2002/96/EEC on electrical and electronic waste (WEEE). Any electrical or electronic equipment marked with this symbol must be disposed of separately from normal domestic waste.

Returning used electrical devices: contact TECSYSTEM or your TECSYSTEM agent for information on the correct disposal of the devices.

TECSYSTEM is aware of the impact its products have on the environment and asks its customers active support in the correct and environmentally-friendly disposal of its devices.

FAILSAFE FUNCTION

The T154 has n.o selection (contact open) / n.c (normally closed contact) for ALARM, TRIP and FAULT relays, programming steps 26 to 31 page 13. The selection of the setting YES/NO introduces functions Fail Safe and No Fail Safe.

ALARM AND TRIP

Setting NO (NO Fail safe) normally open contacts are in positions 5-7 Alarm and 8-10 Trip, they switch only when limits are reached preset temperature.

Setting YES (Fail Safe) normally closed contacts are in positions 5-7 Alarm and 8-10 Trip, they switch only when limits are reached preset temperature.

FAULT

Setting YES (Fail safe) the contact 11-12 is positioned as normally open, switches (closed) when a fault condition is identified; see section on page 11 alarms and ventilation.

Setting NO (NO Fail safe) the contact 11-12 is positioned as normally closed, switches (open) when a fault condition is identified; see section on page 11 alarms and ventilation.

Disabling the failsafe function on the fault contact the unit will no longer be able to report the fault for lack of power. In this case it is suggested that the enabling of the fail safe on the ALARM contact for the above indication.

NOTE: When the unit is located in one of the methods described below does not monitor heat, also the relay will all be banned, the FAULT led start blinking.

- Vis. display programming.
- PRG programming.
- Test of the relays.

The FAIL SAFE is temporarily disabled The FAULT relay switches.

USEFUL CONTACTS

TECHNICAL INFORMATION: ufficiotecnico@tecsystem.it

COMMERCIAL INFORMATION: info@tecsystem.it



UL SPECIFICATION AND RATINGS

CABLE SPECIFICATION	Dimension for main circuit 18AWG, working temperature over 105°C
MASS OF THE EQUIPMENT	0,45 Kg
INPUT SUPPLY	24 – 240 Vac / Vdc ($\pm 10\%$), 50/60 Hz, 7,5VA max
PROTECTION	External switch or circuit breaker
OUTPUTS RELAYS	5 Relay Output: 10A 250Vca-res COS=1
Suitable for use on a flat surface of a type 1 enclosure if Back panel is provided with two short fixing screws tightening torque : 0.57Nm	

C01 T154 -V- ED16 CHANGES VERSION

When at the starting the device shows the message T154 C01 means that: you have purchased the model T 154 -V-

What are the changes introduced in the T154 model -V-:

Programming with default values: ALARM 120 ° C (CH1-2-3) - TRIP 135 ° C (CH1-2-3) - FAN YES (CH1-CH2-CH3) - FAN ON 90 ° C - 80 ° C FAN OFF - CH4 YES - ALARM 130 ° C (CH4) - TRIP 145 ° C (CH4) - HFN NO - NO FCD - VOT YES.

Introduction of the Voting feature, activated by default, voting programming pages 12-13 steps 24-25.

VOTING FUNCTION

The voting function derives from the redundancy concept that consists in duplicating the components of a system to increase their **reliability**.

How does VOTING work?

Using the redundancy principle, we use the sensors installed on the three phases U-V-W to monitor the transformer's operation, and at the same time ascertain the sensors are working correctly, discriminating against any false alarms (generated by installation errors).

By activating the **VOTING "YES"** function, the control unit compares the temperature values recorded on the monitored CH1-CH2-CH3 channels and enables the switching of the **TRIP** contact only if the **TRIP** threshold has been exceeded on at least two channels over the same period T.

By selecting **VOTING "NO"** the function will be disabled.

Note: by setting Voting "Yes" the switching of the **ALARM** contact will anyway indicate the alarm threshold on each individual channel has been exceeded.

To disable the Voting function, read the programming section on pages 12-13.



Attention: To control the transformer correctly from a temperature point of view, enabling the VOTING function is allowed where the load distributed between the phases of the transformer is adequately balanced. In addition, any conditions of FAULT: FCC-FCC-FCD on two or more channels, with active voting, can determine the TRIP contact inhibition.