

Guideline for Air Nipper Cutting Capability

For air nipper blades, the cutting capability changes depending on the shape and types of articles to be cut. Use the values in the following table as reference.



Slide-off air nipper blade

Model No.		CapacityΦ			
Body No.	Shape	Soft palastic	Hard Plastic	Copper	Steel
NY03	AJ	2.0	1.3		
NY03	AJL	1.6	1.1		
NY03	AJT	2.0	1.3		
NY03	RAJ	2.0	1.3		
NY05	BJ		2.0	1.6	1.0
NY05	AJ	3.0	2.0		
NY05	AJL	2.8	1.6		
NY05	AJB	3.0	2.0		
NY05	AJT	3.0	2.0		
NY05	AH	3.0	2.0		
NY05	RBJ		2.0	1.6	1.0
NY05	RAJ	3.0	2.0		
NY05	RAH	3.0	2.0		
NY10	AJ	3.5	2.3		
NY10	AJL	3.2	2.1		
NY10	AD	2.3	1.6		
NY10	AJB	3.5	2.3		
NY10	AJT	3.5	2.3		
NY10	AH	3.5	2.3		
NY10	RAJ	3.5	2.3		
NY10	RAH	3.5	2.3		
NY15	AJ	4.0	2.6		
NY15	AJL	3.7	2.3		
NY15	AD	2.6	2.2		
NY15	AJB	4.0	2.6		
NY15	AJT	4.0	2.6		
NY15	AH	4.0	2.6		
NY15	RAJ	4.0	2.6		
NY15	RAH	4.0	2.6		
NY25	AJ	5.0	3.4		
NY25	AJL	4.7	3.0		
NY25	AD	3.3	2.0		
NY25	AJB	5.0	3.4		
NY25	AH	5.0	3.4		
NY25	RAJ	5.0	3.4		
NY25	RAH	5.0	3.4		

For Horizontal-Type
(Normal-Reversed)

Model No.		CapacityΦ			
Body No.	Shape	Soft palastic	Hard Plastic	Copper	Steel
NT03	AJ	1.5	1.0		
NT03	AJT	1.5	1.0		
NT03	AJY	1.5	1.0		
NE5	AJ	2.5	1.5		
NT05	AJ	2.5	1.5		
NT05	AJL	2.0	1.3		
NT05	AJB	2.5	1.5		
NT05	AJT	2.5	1.5		
NT05	AJY	2.5	1.5		
NT05	AD	2.5	1.2		
NT05	AJH	2.5	1.5		
NT05	AJV	2.5	1.5		
NT05	AE	2.5	1.3		
NE10	AJ	3.5	2.3		
NT10	AJ	3.5	2.3		
NT10	AJL	3.0	2.0		
NT10	AJB	3.5	2.3		
NT10	AJT	3.5	2.3		
NT10	AJY	3.5	2.3		
NT10	AD	3.5	2.1		
NT10	AJH	3.5	2.3		
NT10	AJV	3.5	2.3		
NT10	AE	3.5	2.1		
NT20	AJ	5.0	3.4		
NT20	AJL	4.5	3.2		
NT20	AD	5.0	2.0		
NT20	AJB	5.0	3.4		
NT20	AJH	5.0	3.4		

For Vertical-Type
(Normal and Reversed combined)

Air nipper blade

Model No.		CapacityΦ				
Body No.	Shape	Soft palastic	Hard Plastic	Copper	Steel	Piano Wire
N3	AS			1.0	0.5	
N3	HS			1.0	0.5	
N3	AP	2.0				
N3	AE	2.0				
N3	BJ			1.0	0.5	
N5	AS			1.0	0.5	
N5	HS			1.0	0.5	
N5	AP	2.0				
N5	AE	2.0				
N5	BJ			1.0	0.5	
N7	AS			1.6	1.0	
N7	HS			1.6	1.0	
N7	AP	3.0	2.0			
N7	PF	3.0	2.0			
N7	AE	3.0	2.0			
N7	BJ			1.6	1.0	
N10	AS			1.8	1.2	
N10	HS			1.8	1.2	
N10	AP	4.0	2.6			
N10L	AS			1.8	1.2	
N10L	AP	4.0	2.6			
N10L	PF	4.0	2.6			
N12	AS			2.3	1.7	
N12	HS			2.3	1.7	
N12	AP	4.5	4.0			
N20	AS			2.6	2.0	
N20	HS			2.6	2.0	
N20	AG			2.6	2.0	
N20	AP	7.0	5.0			
N20	AJ	7.0	5.0			
N20	AJL	6.0	4.0			
N20	AJB			5.0		
N20	PF	7.0	5.0			
N20	AE	7.0	5.0			
N20	BFB			2.6	2.0	1.2
N30	AS			3.3	2.8	
N30	BBB			3.3	2.8	1.2
N30	AP	10.0	6.5			
N30	AJ	10.0	6.5			
N30	AJL	8.0	5.0			
N30	PF	10.0	6.5			
N30	AE	10.0	6.5			
N30	ACD	(Bare terminal ^{1.25sq} / _{2.0sq})				
N50	AS			5.5	4.5	
N50	BBB			5.5	4.5	2.0

NM blade

NM20	AJ	7.0	5.0
NM20	AP	7.0	5.0
NM20	AE	7.0	5.0
NM30	AJ	10.0	6.5
NM30	AP	10.0	6.5
NM30	AE	10.0	6.5

For Double Action Air Nipper

NW1	BJ	1.0	0.5
NW10	AJ	4.0	
NW10	BJ	1.8	1.2
NW20	AJ	6.5	
NW20	BJ	2.6	2.0
NW30	AJ	9.5	
NW30	BJ	3.3	2.8

Quasi-standard blade

Model No.		CapacityΦ	
Body No.	Shape	Soft palastic	Hard Plastic
N10	LAB152	3.5	2
N10	LAJ141	3.5	2
N20	AH	6.0	
N20	AML1498	10x1.5	8x1
N20	AMR1499	10x1.5	8x1
N20	AB360	6.5	4.5
N20	AA239	6.5	4.5
N20	AB39	6.5	4.5
N20	AE19	6	4
N20	AA27	6.5	4.5
N20	AK249	5.5	3.5
N20	AE1205	5.5	3.5
N30	AA114	8	5
N30	AE53	7	4.5
N30	AL525	7	4.5
N30	AJ163	8	5
N30	AML1435	15x2	10x1.5
N30	AMR1395	15x2	10x1.5

*Steel wire is non-heat treated.

*Piano wire=HV320 or below. The unit of cutting capability of N20AML and N20AMR is(t).



Contents

- Sliding Air Nippers Horizontal-type 208 - 210
 - Sliding Air Nippers Horizontal-type blades 211 - 212
- Sliding Air Nippers Vertical-type 213
 - Sliding Air Nippers Vertical-type blades 213 - 215
- Thrust-Cut Air Nippers 216
 - Thrust-Cut Air Nipper blades 216
- Heat Air Nippers 217 - 221
- Air Nippers 222 - 225
 - Air Nipper blades 226 - 230
- Air Scissors 231
- Custom-made blades 235

HAND TOOLS

BITS & SOCKETS

ELECTRIC TOOLS

AIR TOOLS

STATIC SOLUTIONS

GASOLINE ENGINE TOOLS

AIR NIPPER TECHNICAL

Tough aluminum body

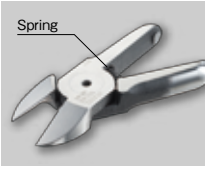

Standard blades

Blades open and close by a spring repulsion.

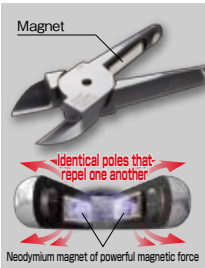

NM blades

Special blade without spring for 24-hour operation; blades open and close by a magnet repulsion.

Air nippers

Model **NY10 A J**
Blade shape



- AJ** : Straight blades for plastic ——— **RAJ** : Straight blades for plastic reverse bevel
- AJL** : Straight long blades for plastic
- AJT** : Thin, straight blades for plastic
- AE** : Nipping blades for plastic
- AJY** : Thin, straight blades for plastic
- AD** : Lift blades for plastic
- AH** : Crank blades for plastic ——— **RAH** : Crank blades for plastic reverse bevel
- AJB** : Straight blades for plastic, a brazed carbide chip
- AJV** : V shaped straight blades for plastic
- AJH** : Straight blades for plastic, a brazed high-speed steel chip
- BJ** : Straight thin blades for metal ——— **RBJ** : Straight thin blades for metal reverse bevel

*The standard blades for the NT, NY, and NW nippers will be changed to the flat-shaped cut type from the current V-shape cut type.

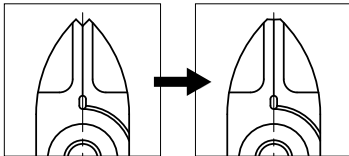

The current V-shape cut type.

The flat-shaped cut type

For more precise gate-cutting:

Heat air nippers

These nippers perform cutting by applying heat to the blade edges. They are good for cutting acrylic lens.



Heat air nippers Thrust-cut type

Cutting by the application of heat; thrust-cutting type ensuring a clean, unblemished cut surface constantly.

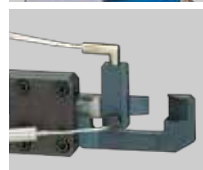

219P

219P

Slide-off air nippers

The main unit of the nipper slides and the blade comes into intimate contact with a gate, enabling to cut it without resin residue.

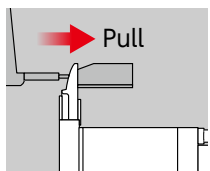

Pull

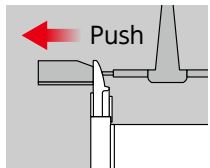

Push

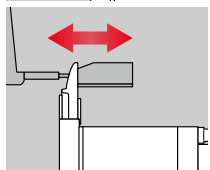

Pull/Push

A wide selection of models can support various applications. Possible to fix the highly precise positioning against the gate as there is less rattling or deflection.

209P

Double action type

Slide mechanism not using a spring ensures smooth action. It is free from concerns about spring wear or metal fatigue, resulting in high durability.

210P



Square type

Provided with threaded holes on the 5 faces of the main unit. Suitable for incorporating into a machine or equipment.

223P



Round type

Possible to adjust freely the mounting angle by a stand (option). Suitable for installation on a robotic arm or chuck plate.

224P



Extra Pressure Booster

Installing this unit on either square or round air nipper enables a pressure to be boosted. Ideal for applications where the radical pressure cannot be attained because of installation space or air pressure.

224P

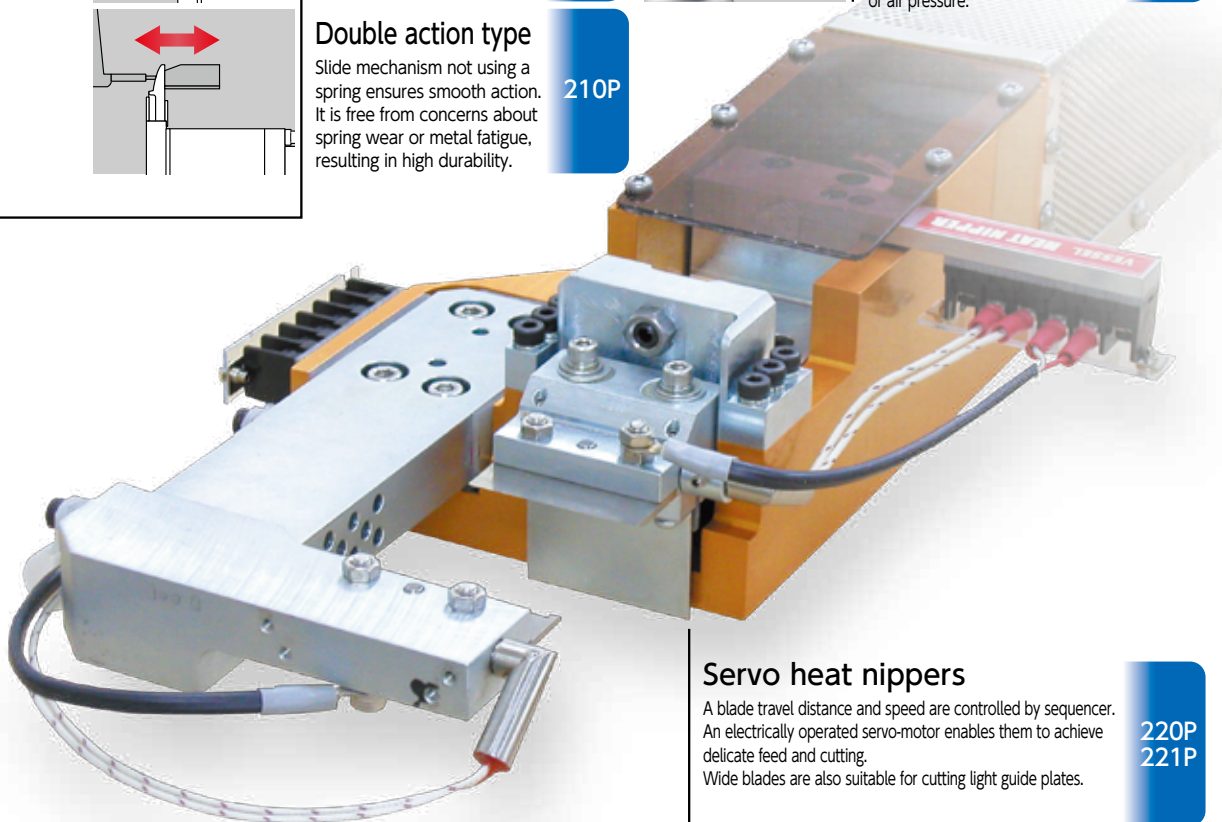

Servo heat nippers

A blade travel distance and speed are controlled by sequencer. An electrically operated servo-motor enables them to achieve delicate feed and cutting. Wide blades are also suitable for cutting light guide plates.

220P
221P

Differences in the cut surfaces when using heat nippers

Standard Blades
(Not Heat Nipper)



Heat Nippers



Air-hydro nippers Thrust-cut type

An air-hydro cylinder of air + oil provides low speeds and high power. These nippers are suitable for precision cutting in which gate projecting allowance is strict.

218P

Applications

HAND TOOLS

BITS & SOCKETS

ELECTRIC TOOLS

AIR TOOLS

STATIC SOLUTIONS

GASOLINE ENGINE TOOLS

Cutting direct gate molded components

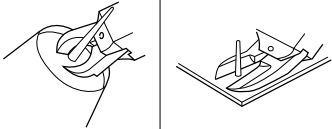

Cuts large diameter sprues such as garment cases, helmets, pipe joint parts, trash cans, planters. Superb durability in long term use.

Gate cut for multiple impression molded components

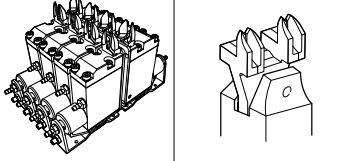

Compact, lightweight body and with a large selection of blade items, easy mounting on chuck board and standby jig. Achieves efficient cuts matching cycle time.

Taking products from a jewelry tree

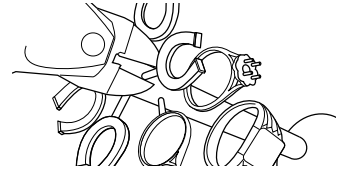

Cutting of precious metals for rings, necklaces etc. Superb durability and increased efficiency with powerful nipper blades.

Gate cutting for lenses, LGP, and transparent products

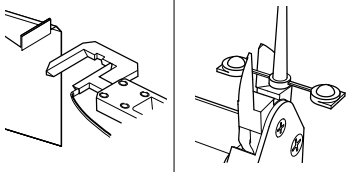

Various heated nippers prevent cracks and whitening, the decisive factor is the heating temperature of the blades and cutting speed. Supports demands for improved flexibility and high precision cutting.

Pre-form cutting for food and drug cases

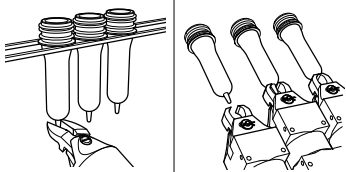

Improved efficiency in pre-forming, nippers attached to flat finish pre-form molding machine. Cut precision is linked to product quality.

Cutting electronic components and around boards

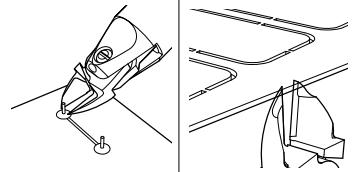

Optimal handy nippers for cutting lead lines after soldering to significantly reduce wrist strain. Substrate is attached to the desktop robot...

Wire cutting with coil winding machine

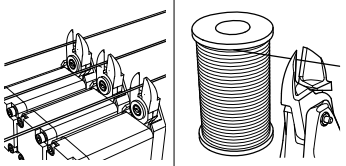

Attach to the nipper unit of automatic coil winding machine for power transformers, fan motors and ignition. Cutting thick diameter wires that cannot be torn off.

Hand tools for dismantling in recycling plants

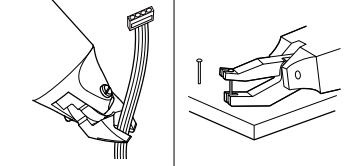

Cuts a variety of wires, copper tubing and steel bands in recycling plants such as PCs and OA equipment, pachinko machines, TVs, and refrigerators, washing machines, etc. Nippers for the purpose of pulling out the pachinko machine pins.

Crimping task for solderless terminals

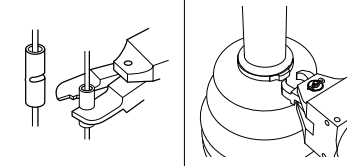

For crimping terminals with various wiring harnesses such as for switchboards, electrical products and lighting equipment. Less strain on fingers and wrists. Increased work efficiency for stop rings for auto parts.

Die cutter for aluminum products and plastic components

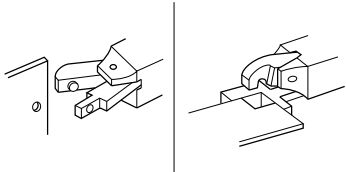

By support for separate blades, allows punching and form cutting of aluminum sash and thin plates.

Punching of blow molded products, punching slotted holes

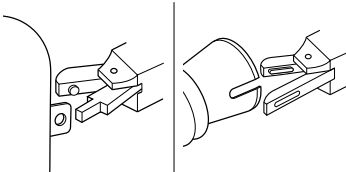

Punching blow molded products, punching slotted holes, for containers that cannot be punched and automobile ducts, etc.

Other applications

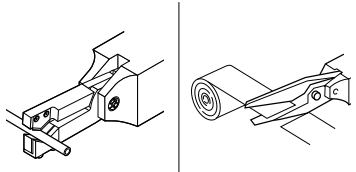

Micro-edge air scissors that can cut various hard-to-cut fibers, carbon, aramid fibers, and soft plastic sheets. Nippers for cutting belt loops of jeans, peeling recycled golf balls, cutting edges with textile machinery, etc.

Selection method for air nipper

Check materials

What is the "cutting target (workpiece)"?

- Metal wire
 - Steel wire
 - Copper wire
 - Piano wire (not heat processed/HV320 or below), precious metals etc.
- Molded plastic
 - Soft plastic (polyvinyl chloride, polyethylene)
 - Hard plastic (acrylic, polycarbonate, ABS, etc.)
- Other applications
 - Check materials, applications and work.
 - (Bending, caulking, punching, robotic hand, and scissors.)

Check dimensions

How big is the "size of the cut portion"?

- Metal
 - Angle (mm×mm) [select model by cross-section area]
 - Round (Φ mm)
- Plastic
 - Angle (mm×mm) [select model by cross-section area]
- Other applications
 - Check materials, applications and work.

Usage

What is the "state/environment of the work"?

- Used mounted on automated machinery and robots.
- Used for manual work.
- Used mounted on a jig. And so forth

Select model

Choose a model suitable for the purpose.

- Choose based on "usage and cut dimensions" for the main unit, and "material and dimensions/shape" for the blades.
- Refer to "product specifications" for the main unit/blade characteristics/usage, respectively. Also when selecting the machine, refer to "capability selection chart".
- The shape/material of the workpiece may not be compatible with standard products.

Guidance for capability selection

Note: Reference value when a standard blade is mounted.
Values vary depending on the blade shapes and types of cut objects.

Types	Cutting material							Applicable models	Air pressure (MPa)
	Copper wire	Steel wire (Non-heat treated)	Piano wire (HV320 or below)	Soft plastic		Hard plastic	Solderless terminals		
				Dia.	Cross-section				
N · NS · NR	1.0mm	0.5mm	0.2mm	2.0mm	3.1mm ²			NS2,N3,NS3,NR3	0.4~0.5
	1.0	0.5	0.3	2.0	3.1			N5,NS5,NR5	0.4~0.5
	1.6	1.0	0.5	3.0	7.0	2.0mm		N7,NS7,NR7	0.4~0.5
	1.8	1.2	0.5	4.0	12.5	2.6		N10,NS10L,NR10L	0.5~0.6
	2.3	1.7	0.6	4.5	15.8	4.0		N12	0.5~0.6
	2.6	2.0	1.0	7.0	38.4	5.0		N20,NS20,NR20	0.5~0.6
	3.3	2.8	1.2	10.0	78.5	6.5	1.25/2.0	N30,NS30,NR30	0.5~0.6
	5.5	4.5	2.0	12.0	113.0	6.5		N50,NR50	0.5~0.6
With pressure booster	2.6	1.6		5.0	19.6	4.0	1.25/2.0	P-10L	
	3.0	2.2		8.0	50.2	6.0	2.0/5.5	P-20	
	4.8	4.0		13.0	132.6	7.0	~0.8	P-30	
	6.5	5.5						P-50	
NY	1.6	1.0		2.0	3.1	1.3		NY03	0.4~0.5
				3.0	7.0	2.0		NF05,NY05	0.4~0.5
				3.5	9.6	2.3		NF10,NY10	0.4~0.5
				4.0	12.5	2.6		NF15,NY15	0.4~0.5
				5.0	19.6	3.4		NY25	0.5~0.6
NT				1.5	1.7	1.0		NT03	0.4~0.5
				2.5	4.9	1.5		NT05	0.4~0.5
				3.5	9.6	2.3		NT10	0.4~0.5
				5.0	19.6	3.4		NT20	0.4~0.5
	AS, HS, BJ type		BBB	AP, PF, AJ type			ACD type		

No. GT-NY25

Sliding Air Nippers



These are high-class air nippers that can be mounted on gate cutting equipment and standby jigs for accurate, speedy cutting of resin products. VESSEL has a wide selection of items to meet a variety of needs not only for around-the-clock operations but also for the highly precise cutting accuracy.



No. GT-NY25

Sliding Air Nippers Horizontal-Type

The horizontal slide enables space to be utilized effectively. The low profile of the nipper body allows objects to be removed from the machine without obstructing the operations of the chuck plate.

HAND TOOLS

BITS & SOCKETS

ELECTRIC TOOLS

AIR TOOLS

STATIC SOLUTIONS

GASOLINE ENGINE TOOLS

No. GT-NY05/10/15/25 Sliding Air Nippers Horizontal-Type

- The horizontal slide enables space to be utilized effectively.
- The low profile of the nipper body allows objects to be removed from the machine without obstructing the operations of the chuck plate.

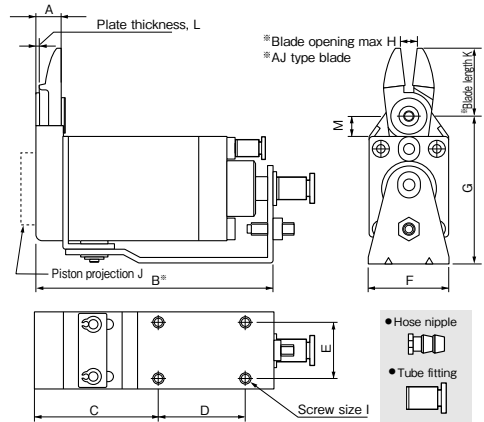

Reference

Capacity ϕ (mm)				Model No.	Size (mm)													Air Consumption (cm ³ /str.)	Weight (g)	Slide Distance (mm)	Hose Port	EDP No.
Soft Plastic	Hard Plastic	Copper	Steel		A	B	C	D	E	F	G	H	I	J	K	L	M					
3.0	2.0	1.6	1.0	GT-NY05																		
3.0	2.0	1.6	1.0	GT-NY05R	8.6	75.9	40.9	25	15	23	47.6	4	M4	3	22	1.6	8.5					
3.0	2.0	1.6	1.0	GT-NY05-4																		
3.0	2.0	1.6	1.0	GT-NY05R-4																		
3.5	2.3			GT-NY10																		
3.5	2.3			GT-NY10R	8.8	82.1	42.1	30	20	28	51.6	6	M4	5	24	1.6	7.5					
3.5	2.3			GT-NY10-4																		
3.5	2.3			GT-NY10R-4																		
4.0	2.6			GT-NY15																		
4.0	2.6			GT-NY15R	10.2	93	48	35	25	33	58	8	M4	5	27	2	7.5					
4.0	2.6			GT-NY15-4																		
4.0	2.6			GT-NY15R-4																		
5.0	3.4			GT-NY25																		
5.0	3.4			GT-NY25R	12.5	108.5	54.5	40	30	42	69	9	M5	2	31	2.5	10.5					
5.0	3.4			GT-NY25-6																		
5.0	3.4			GT-NY25R-6																		

*Capacity indication shows the reference value when a standard blade is mounted. Values vary depending on the blade shapes and type of cut objects.
 *K (blade projection) and H (maximum blade opening) indicate the dimensions when a standard blade (AJ type) is mounted. *Air Pressure--0.4~0.5MPa (NY25 type: 0.5~0.6)
 *B refers to the distance from the cut position for PUSH style models, and the distance from the start position for PULL style models.

No. GT-NY03G/10G Sliding Air Nippers Horizontal-Type

- V-groove slide base ensures constant, stable positioning.
- The unit is not subject to inclined loads, and has achieved high precision gate cutting performance.

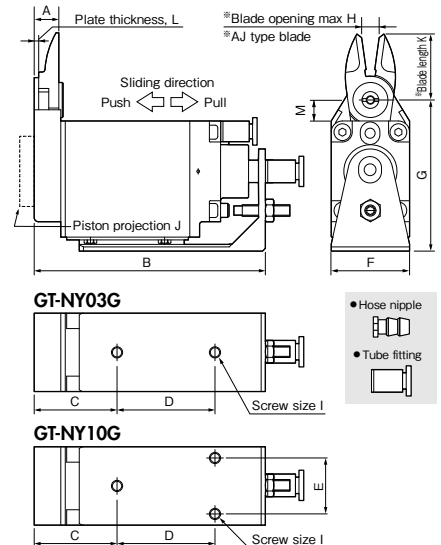
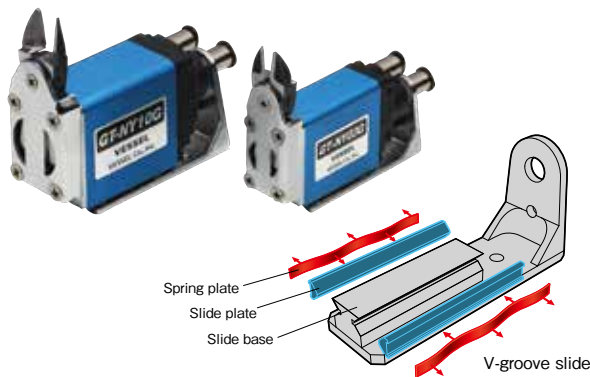

Reference

Capacity ϕ (mm)				Model No.	Size (mm)													Air Consumption (cm ³ /str.)	Weight (g)	Slide Distance (mm)	Hose Port	EDP No.
Soft Plastic	Hard Plastic				A	B	C	D	E	F	G	H	I	J	K	L	M					
2.0	1.3			GT-NY03G																		
2.0	1.3			GT-NY03GR	8.6	74.5	29.5	30	-	19	46.5	3	M4	0	21	1.6	7.5					
2.0	1.3			GT-NY03G-4																		
2.0	1.3			GT-NY03GR-4																		
3.5	2.3			GT-NY10G																		
3.5	2.3			GT-NY10GR	8.8	82.6	29.6	35	20	28	54	6	M4	5	24	1.6	7.5					
3.5	2.3			GT-NY10G-4																		
3.5	2.3			GT-NY10GR-4																		

*Capacity indication shows the reference value when a standard blade is mounted. Values vary depending on the blade shapes and type of cut objects. *K (blade projection) and H (maximum blade opening) indicate the dimensions when a standard blade (AJ type) is mounted. *Air Pressure--0.4~0.5MPa

※Blades are optional. Note that a forward or a backward-facing blades are respectively available.

No. GT-NY10S/25S Double Action Sliding Air Nippers

- The springless slide construction of the main unit ensures smooth movement.
- V-groove slide base has been employed for high precision positioning.

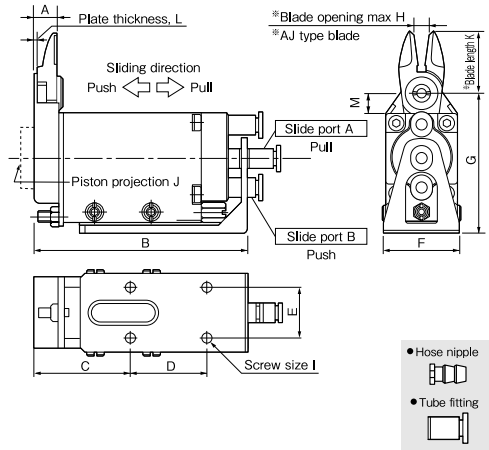
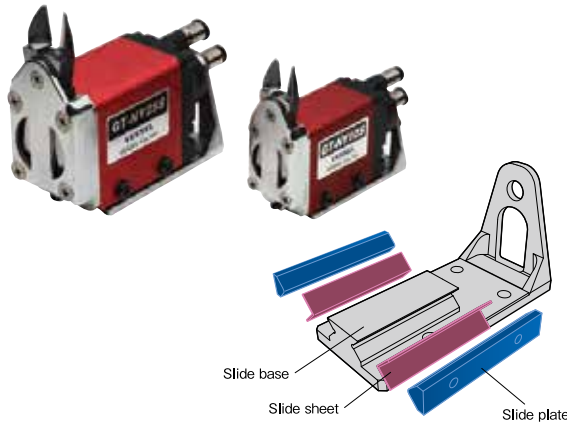

Reference

Capacity ϕ (mm) Soft Plastic Hard Plastic	Model No.	Size (mm)													Air Consumption (cm ³ /str.)	Weight (g)	Slide Distance (mm)	Hose Port	EDP No.
		A	B	C	D	E	F	G	H	I	J	K	L	M					
3.5 2.3	GT-NY10S	8.8	84.5	38	30	20	32	55	6	M4	5	24	1.6	7.5	68	300	0~3.5	W/tube fitting Hose I.D. ϕ 2.5×O.D. ϕ 4mm	360731
5.0 3.4	GT-NY25S	12.5	106.5	47	40	30	47	72	9	M5	2	31	2.5	10.5	184	695	0~5.0	W/tube fitting Hose I.D. ϕ 4×O.D. ϕ 6mm	360732

※Capacity indication shows the reference value when a standard blade is mounted. Values vary depending on the blade shapes and type of cut objects.
 ※K (blade projection) and H (maximum blade opening) indicate the dimensions when a standard blade (AJ type) is mounted.
 ※Air Pressure--NY10S: 0.4~0.5MPa / NY25S: 0.5~0.6MPa

No. GT-NF05/10/15 Type-F Air Nippers

- These compact, lightweight nippers have been designed for easy mounting inside equipment and to enable secure mounting under high-density mounting conditions.

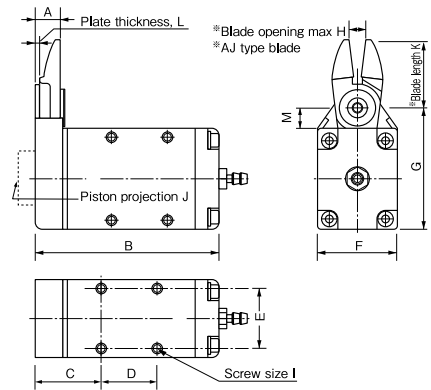

Reference

Capacity ϕ (mm) Soft Plastic Hard Plastic Copper Steel	Model No.	Size (mm)													Air Consumption (cm ³ /str.)	Weight (g)	Hose Port	EDP No.
		A	B	C	D	E	F	G	H	I	J	K	L	M				
3.0 2.0 1.6 1.0	GT-NF05	8.6	59.9	21.9	17	18	23	39.5	4	M3	3	22	1.6	8.4	43	101	W/hose nipple	360606
3.5 2.3 1.7 1.1	GT-NF10	8.8	65.1	23.1	20	22	28	43.5	6	M3.5	5	24	1.6	7.4	63	143	Hose I.D. ϕ 2.5× ϕ 4mm	360607
4.0 2.6 1.8 1.2	GT-NF15	10.2	73	25	25	26	33	48.5	8	M4	5	27	2	7.4	128	219		360608

※Capacity indication shows the reference value when a standard blade is mounted. Values vary depending on the blade shapes and type of cut objects.
 ※K (blade projection) and H (maximum blade opening) indicate the dimensions when a standard blade (AJ type) is mounted. Mounting screw for NF10 (M3.5) is regarded as spare part.
 ※Air Pressure--0.4~0.5MPa

No. AJ/RAJ/AJB Straight blades for plastic

Plastic **AJ**/This is a set of vertical blades with an unbeveled cutting edge. This can cut a gate of molded objects vertically and straight.
RAJ/This is a reverse bevel of AJ type.
AJB/This has a brazed carbide chip used for cutting hard plastic or plastic containing glass fiber.

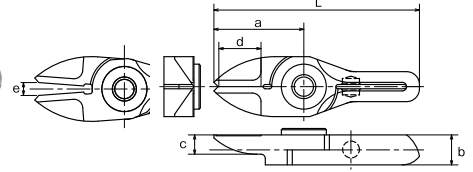

Model No.	Size (mm)						Weight (g)	Material	Applicable models	EDP No.
	a	b	c	d: Effective Length	e: Blade opening	L				
NY03AJ	21	7	4.5	10.5	3	48	17	Special alloy steel	GT-NY03G(-4)	360591
NY03RAJ	21	7	4.5	10.5	3	48	17	Special alloy steel	GT-NY03GR(-4)	360594
NY05AJ	22	7	5	10.5	4	53	22	Special alloy steel	GT-NY05(-4) / NF05	360551
NY05RAJ	22	7	5	10.5	4	53	22	Special alloy steel	GT-NY05R(-4) / NF05	360556
NY05AJB	22	7	5	10.5	4	53	22	w/Carbide chip	GT-NY05(-4) / NF05	360553
NY10AJ	24	7.2	5	12	6	57	28	Special alloy steel	GT-NY10(-4) / NY10G(-4) / NF10 / NY10S	360561
NY10RAJ	24	7.2	5	12	6	57	28	Special alloy steel	GT-NY10R(-4) / NY10GR(-4) / NF10 / NY10S	360566
NY10AJB	24	7.2	5	12	6	57	28	w/Carbide chip	GT-NY10(-4) / NY10G(-4) / NF10 / NY10S	360563
NY15AJ	27	8.2	5.5	13	8	65	41	Special alloy steel	GT-NY15(-4) / NF15	360571
NY15RAJ	27	8.2	5.5	13	8	65	41	Special alloy steel	GT-NY15R(-4) / NF15	360576
NY15AJB	27	8.2	5.5	13	8	65	41	w/Carbide chip	GT-NY15(-4) / NF15	360573
NY25AJ	31	10	6	16	9	77	65	Special alloy steel	GT-NY25(-6) / NY25S	360583
NY25RAJ	31	10	6	16	9	77	65	Special alloy steel	GT-NY25R(-6) / NY25S	360587
NY25AJB	31	10	6	16	9	77	65	w/Carbide chip	GT-NY25(-6) / NY25S	360585

>> For guidance on cutting capability, see P264 of the technical material.

*Subject to change in the blade tip specifications (NY25 types remain same). See P204.

No. RAJB Straight blades for plastic (with carbide chip)

Plastic **AJB**/This is a straight blade with carbide chip brazed at the cutting edge. Can place it along the gate at the right angle. Good for hard plastics or glass fiber containing plastics.

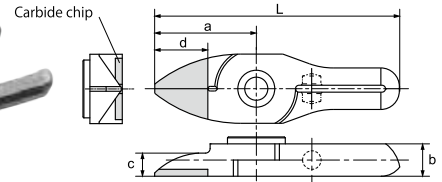

Model No.	Size (mm)						Weight (g)	Material	Applicable models	EDP No.
	a	b	c	d: Effective Length	e: Blade opening	L				
NY05RAJB	22	7	5	10.5	4	53	32	w/Carbide chip	GT-NY05R(-4) / NF05	360579
NY10RAJB	24	7.2	5	12	6	57	38	w/Carbide chip	GT-NY10R(-4) / NY10GR(-4) / NF10 / NY10S / NF10	360580
NY15RAJB	27	8.2	5.5	13	8	65	48	w/Carbide chip	GT-NY15R(-4) / NF15	360581
NY25RAJB	31	10	6	16	9	77	78	w/Carbide chip	GT-NY25R(-6) / NY25S	360582

>> For guidance on cutting capability, see P264 of the technical material.

No. AJL Straight long blades for plastic

Plastic **AJL**/This is a long type set of straight blades. This is useful when there is distance between the nipper and the gate cut portion of the molded object.

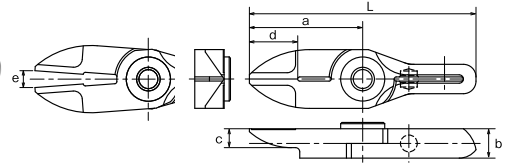

Model No.	Size (mm)						Weight (g)	Material	Applicable models	EDP No.
	a	b	c	d: Effective Length	e: Blade opening	L				
NY03AJL	27	7	4.5	10.5	4	54	21	Special alloy steel	GT-NY03G(-4)	360592
NY05AJL	31	7	5	10.5	5.5	62	29	Special alloy steel	GT-NY05(-4) / NF05	360552
NY10AJL	33	7.2	5	12	8	66	37	Special alloy steel	GT-NY10(-4) / NY10G(-4) / NF10 / NY10S	360562
NY15AJL	38	8.2	5.5	13	11	76	50	Special alloy steel	GT-NY15(-4) / NF15	360572
NY25AJL	46	10	6	16	13	92	88	Special alloy steel	GT-NY25(-6) / NY25S	360584

>> For guidance on cutting capability, see P264 of the technical material.

*Subject to change in the blade tip specifications (all models except NY03 type remain same). See P204.

No. RAJL Straight long blades for plastic

Plastic **AJL**/This is a long type set of straight blades. This is useful when there is a distance between the nipper and the gate cutting point of the molded products.

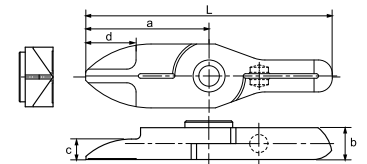

Model No.	Size (mm)						Weight (g)	Material	Applicable models	EDP No.
	a	b	c	d: Effective Length	e: Blade opening	L				
NY03RAJL	27	7	4.5	10.5	4	54	35	Special alloy steel	GT-NY03GR(-4)	360595
NY05RAJL	31	7	5	10.5	5.5	62	36	Special alloy steel	GT-NY05R(-4) / NF05	360596
NY10RAJL	33	7.2	5	12	8	66	44	Special alloy steel	GT-NY10R(-4) / NY10GR(-4) / NF10 / NY10S / NF10	360597
NY15RAJL	38	8.2	5.5	13	11	76	58	Special alloy steel	GT-NY15R(-4) / NF15	360598
NY25RAJL	46	10	6	16	13	92	95	Special alloy steel	GT-NY25R(-6) / NY25S	360599

>> For guidance on cutting capability, see P264 of the technical material.

No. AJT Thin, straight blades for plastic

Plastic **AJT**/This is a set of straight blades with a thin cutting edge. It can cleanly trim cross sections without remnants.

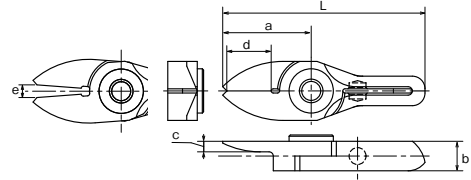

Model No.	Size(mm)						Weight (g)	Material	Applicable models	EDP No.
	a	b	c	d: Effective Length	e: Blade opening	L				
NY03AJT	21	7	2.5	10.5	3	48	17	Special alloy steel	GT-NY03G(-4)	360593
NY05AJT	22	7	3	10.5	4	53	21	Special alloy steel	GT-NY05(-4) / NF05	360554
NY10AJT	24	7.2	3	12	6	57	26	Special alloy steel	GT-NY10(-4) / NY10G(-4) / NF10 / NY10S	360564
NY15AJT	27	8.2	3.5	13	8	65	38	Special alloy steel	GT-NY15(-4) / NF15	360574

>> For guidance on cutting capability, see P264 of the technical material.

*Subject to change in the blade tip specifications. See P204.

No. AD Lift blades for plastic

Plastic **AD**/This is used for batch processing of the three-dimensional gate such as ride gate.

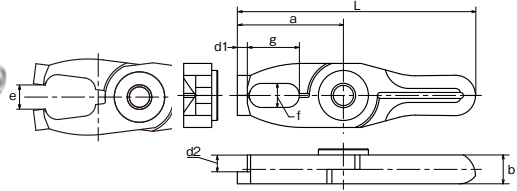

Model No.	Size(mm)			d1 (mm)	d2 (mm)	e: Blade opening (mm)	L (mm)	Weight (g)	Material	Applicable models	EDP No.
	a	b	f×g								
NY10AD	26.5	7.2	6×13	2.5	4.2	6	59.5	31	Special alloy steel	GT-NY10(-4) / NY10G(-4) / NF10 / NY10S	360568
NY15AD	30	8.2	7×14	3	4.7	8	68	45	Special alloy steel	GT-NY15(-4) / NF15	360578
NY25AD	35	10	8×17	4	6	9	81	75	Special alloy steel	GT-NY25(-6) / NY25S	360589

>> For guidance on cutting capability, see P264 of the technical material.

No. AH/RAH Crank blades for plastic

Plastic **AH**/This is a set of crank shaped blade for plastic. It is effective when there are obstructions or the gate is narrow.
RAH/This is a reverse bevel of AH type used when installing the main units face-to-face.

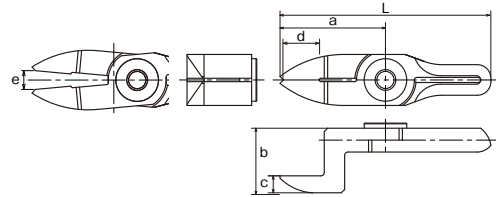

Model No.	Size(mm)						Weight (g)	Material	Applicable models	EDP No.
	a	b	c	d: Effective Length	e: Blade opening	L				
NY05AH	31	19	5	10.5	5.5	62	37	Special alloy steel	GT-NY05(-4) / NF05	360555
NY05RAH	30	12	5	10.5	5	61	31	Special alloy steel	GT-NY05R(-4) / NF05	360557
NY10AH	33	20	5	12	8	66	43	Special alloy steel	GT-NY10(-4) / NY10G(-4) / NF10 / NY10S	360565
NY10RAH	32	12.2	5	12	7	65	36	Special alloy steel	GT-NY10R(-4) / NY10GR(-4) / NF10 / NY10S	360567
NY15AH	38	21.5	5.5	13	11	76	63	Special alloy steel	GT-NY15(-4) / NF15	360575
NY15RAH	35	13.2	5.5	13	9	73	52	Special alloy steel	GT-NY15R(-4) / NF15	360577
NY25AH	46	24	6	17	13	92	110	Special alloy steel	GT-NY25(-6) / NY25S	360586
NY25RAH	42	16	6	16	12	88	89	Special alloy steel	GT-NY25R(-6) / NY25S	360588

>> For guidance on cutting capability, see P264 of the technical material.

*Subject to change in the blade tip specifications (NY25 types remain same). See P204.

No. BJ/RBJ Straight blades for metals

Metal **BJ**/This is a set of vertical blades with an unbeveled cutting edge for metal.
RBJ/This is a reverse bevel of BJ type.

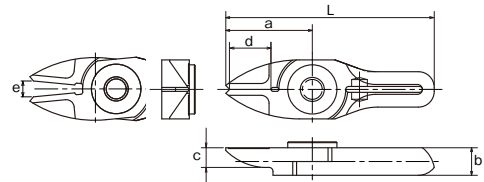

Model No.	Size(mm)						Weight (g)	Material	Applicable models	EDP No.
	a	b	c	d: Effective Length	e: Blade opening	L				
NY05BJ	22	7	5	10.5	4	53	22	Special alloy steel	GT-NY05(-4) / NF05	360558
NY05RBJ	22	7	5	10.5	4	53	22	Special alloy steel	GT-NY05R(-4) / NF05	360559

>> For guidance on cutting capability, see P264 of the technical material.

*Subject to change in the blade tip specifications. See P204.

No. GT-NT03/05/10/20 Sliding Air Nippers Vertical-type

- Blade opening is adjustable, and fine adjustments are easy to make after mounting the nippers, ensuring clean, unblemished cut surfaces.
- Blade can be installed either with the cutting edge outside or inside.

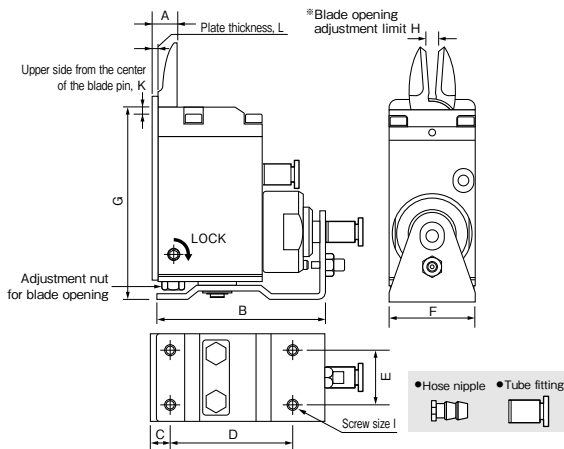

Reference

Capacity ϕ (mm)		Model No.	Size (mm)											Air Consumption (cm ³ /str.)	Weight (g)	Slide Distance (mm)	Hose Port	EDP No.	
Soft Plastic	Hard Plastic		A	B	C	D	E	F	G	H	I	J	K						
1.5	1.0	GT-NT03													27	178	Pull 0~3	W/hose nipple	360601
1.5	1.0	GT-NT03R													27	178	Push 0~3	Hose I.D ϕ 2.5mm	360611
1.5	1.0	GT-NT03-4	9	62	7	43	14	19	68.1	1.5~3	M3	2	5	27	178	Pull 0~3	W/tube fitting	360621	
1.5	1.0	GT-NT03R-4												27	178	Push 0~3	Hose I.D ϕ 2.5xO.D. ϕ 4mm	360631	
2.5	1.5	GT-NT05												47	325	Pull 0~3	W/hose nipple	360602	
2.5	1.5	GT-NT05R												47	325	Push 0~3	Hose I.D ϕ 2.5mm	360612	
2.5	1.5	GT-NT05-4	9	64	7	45	20	32	71.1	3~6	M4	2	5	47	325	Pull 0~3	W/tube fitting	360622	
2.5	1.5	GT-NT05R-4												47	325	Push 0~3	Hose I.D ϕ 2.5xO.D. ϕ 4mm	360632	
3.5	2.3	GT-NT10												82	515	Pull 0~3	W/hose nipple	360603	
3.5	2.3	GT-NT10R												82	515	Push 0~3	Hose I.D ϕ 2.5mm	360613	
3.5	2.3	GT-NT10-6	11	73	8	53	24	38	88.1	4~7	M4	2	5	82	515	Pull 0~3	W/tube fitting	360623	
3.5	2.3	GT-NT10R-6												82	515	Push 0~3	Hose I.D ϕ 4xO.D. ϕ 6mm	360633	
5.0	3.4	GT-NT20												203	930	Pull 0~8	W/hose nipple	360604	
5.0	3.4	GT-NT20R												203	930	Push 0~8	Hose I.D ϕ 4mm	360614	
5.0	3.4	GT-NT20-6	14	103	10	80	28	44	102.1	4.5~9	M5	2	6	203	930	Pull 0~8	W/tube fitting	360624	
5.0	3.4	GT-NT20R-6												203	930	Push 0~8	Hose I.D ϕ 4xO.D. ϕ 6mm	360634	

*Capacity indication shows the reference value when a standard blade is mounted. Values vary depending on the blade shapes and type of cut objects.
 *Blade opening adjustment limit (H) is the dimension adjusted for standard blade (AJ type). *Air Pressure:~0.4~0.5MPa(NT20 type: 0.5~0.6)

No. AJ/AJH/AJB Straight blades for plastic

- Plastic** **AJ**/This is a set of vertical blades with an unbeveled cutting edge. This can cut a gate of molded objects vertically and straight.
AJH/This has a brazed high-speed steel chip suitable for cutting hard plastic.
AJB/This has a brazed carbide chip used for cutting hard plastic or plastic containing glass fiber. Improved durability.

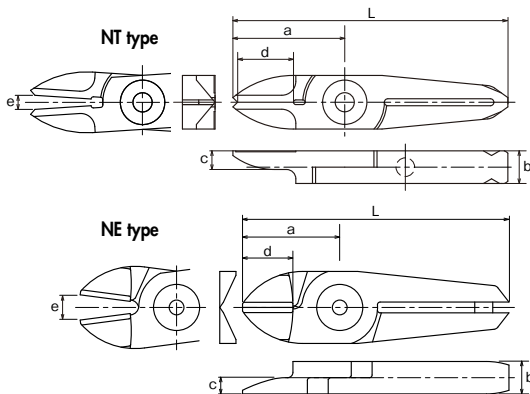

Model No.	Size (mm)							Weight (g)	Material	Applicable models	EDP No.
	a	b	c	d: Effective Length	e: Blade opening	L					
NT03AJ	24	7	4	11	3	59	20	Special alloy steel	GT-NT03 type	360511	
NT05AJ	29	7	5	15	6	65	30	Special alloy steel		360512	
NT05AJH	29	7	5	15	6	65	30	High Speed Steel w/Carbide chip	GT-NT05 type	360534	
NT05AJB	29	7	5	15	6	65	30	High Speed Steel w/Carbide chip		360515	
NE5AJ	24	7	3.5	12	6	60	35	Special alloy steel		360184	
NT10AJ	35	9	6	17	7	82	62	Special alloy steel		360513	
NT10AJH	35	9	6	17	7	82	76	High Speed Steel w/Carbide chip	GT-NT10 type	360539	
NT10AJB	35	9	6	17	7	82	76	High Speed Steel w/Carbide chip		360518	
NE10AJ	27	9	4.5	12	7	74	70	Special alloy steel		360185	
NT20AJ	40	12	6	20	9	97	120	Special alloy steel		360514	
NT20AJH	40	12	6	20	9	97	120	High Speed Steel	GT-NT20 type	360544	
NT20AJB	40	12	6	20	9	97	120	w/Carbide chip		360543	

>> For guidance on cutting capability, see P264 of the technical material.

*Subject to change in the blade tip specifications (NE types remain same). See P204.

No. AJL Straight long blades for plastic

Plastic **AJL**/This is a long type set of straight blades. This is useful when there is distance between the nipper and the gate cut portion of the molded object.

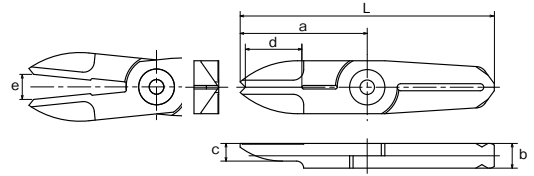

Model No.	Size (mm)						Weight (g)	Material	Applicable models	EDP No.
	a	b	c	d: Effective Length	e: Blade opening	L				
NT05AJL	36	7	5	15	7	72	39	Special alloy steel	GT-NT05 type	360516
NT10AJL	47	9	6	17	9	94	62	Special alloy steel	GT-NT10 type	360520
NT20AJL	57	12	6	20	12	114	156	Special alloy steel	GT-NT20 type	360541

>> For guidance on cutting capability, see P264 of the technical material.

*Subject to change in the blade tip specifications. See P204.

No. AJT Thin, straight blades for plastic

Plastic **AJT**/This is a set of straight blades with a thin cutting edge. It can cleanly trim cross sections without remnants.

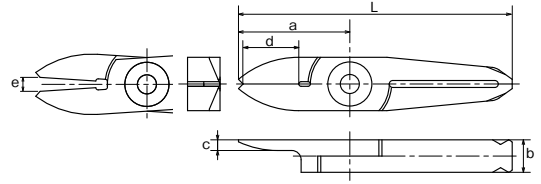

Model No.	Size (mm)						Weight (g)	Material	Applicable models	EDP No.
	a	b	c	d: Effective Length	e: Blade opening	L				
NT03AJT	24	7	2.3	11	3	59	19	Special alloy steel	GT-NT03 type	360526
NT05AJT	29	7	3	15	6	65	29	Special alloy steel	GT-NT05 type	360531
NT10AJT	35	9	4	17	7	82	65	Special alloy steel	GT-NT10 type	360536

>> For guidance on cutting capability, see P264 of the technical material.

Subject to change in the blade tip specifications. See P204.

No. AJY Thin, straight blades for plastic (approaching to a gate)

Plastic **AJY**/This is effective when the width between the opposing gates is too short and the blade cannot go in due to its thickness.

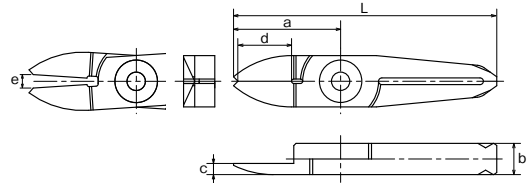

Model No.	Size (mm)						Weight (g)	Material	Applicable models	EDP No.
	a	b	c	d: Effective Length	e: Blade opening	L				
NT03AJY	24	7	2.5	11	3	59	19	Special alloy steel	GT-NT03 type	360527
NT05AJY	29	7	3	15	6	65	29	Special alloy steel	GT-NT05 type	360532
NT10AJY	35	9	4	17	7	72	82	Special alloy steel	GT-NT10 type	360537

>> For guidance on cutting capability, see P264 of the technical material.

Subject to change in the blade tip specifications. See P204.

No. AD Lift blades for plastic

Plastic **AD**/This is used for batch processing of the three-dimensional gate such as ride gate.

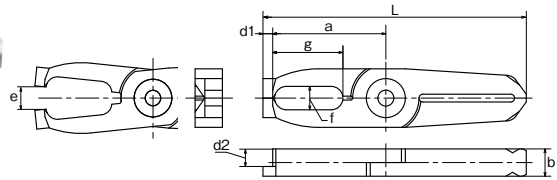

Model No.	Size (mm)			Effective Length (mm)		e: Blade opening (mm)	L (mm)	Weight (g)	Material	Applicable models	EDP No.
	a	b	f×g	d1	d2						
NT05AD	31.5	7	6×18	2.5	4.5	6	67.5	37	Special alloy steel	GT-NT05 type	360533
NT10AD	39	9	8×21.5	4	5	7	86	65	Special alloy steel	GT-NT10 type	360538
NT20AD	46	12	9×24.5	6	7	9	103	141	Special alloy steel	GT-NT20 type	360542

>> For guidance on cutting capability, see P264 of the technical material.

No. AJV V shaped straight blades for plastic



AJV/This is suitable for gate processing when the cross section is curved or the cut end must not be left.

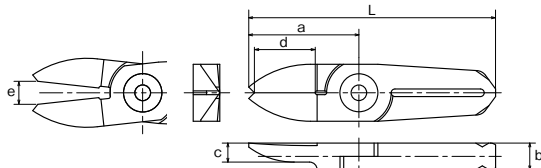

Model No.	Size (mm)						Weight (g)	Material	Applicable models	EDP No.
	a	b	c	d: Effective Length	e: Blade opening	L				
NT05AJV	29	7	5	15	6	65	29	Special alloy steel	GT-NT05 type	360535
NT10AJV	35	9	6	17	7	82	63	Special alloy steel	GT-NT10 type	360540

>> For guidance on cutting capability, see P264 of the technical material.

Subject to change in the blade tip specifications. See P204.

No. AE Nipping blades for plastic



AE/Used for processing plastic gates such as ride gates and discard gates.

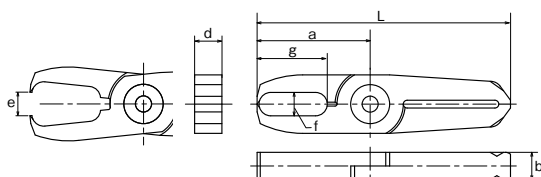

Model No.	Size (mm)						Weight (g)	Material	Applicable models	EDP No.
	a	b	f×g	d: Effective Length	e: Blade opening	L				
NT05AE	29	7	6×18	7	6	65	36	Special alloy steel	GT-NT05 type	360517
NT10AE	35	9	8×21.5	9	7	82	75	Special alloy steel	GT-NT10 type	360519

>> For guidance on cutting capability, see P264 of the technical material.

No. GT-NK10 Thrust-Cut Air Nipper

- This nipper can cut film-shaped gates in conjunction with a foot switch or high precision travers machine.
- Can cut from the thin end, preventing wrinkles around the cut edge.

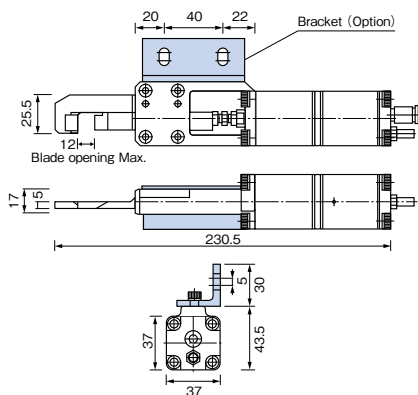

Reference

Capacity ϕ (mm) ABS Plastic	Model No.	Air Consumption (cml/str.)	Air Pressure (MPa)	Weight (g)	Applied Pressure (N)	Spec. & Size of the Hose Port	EDP No.
5	GT-NK10	110	0.4~0.5	800	735	Hose I.D. ϕ 2.5×O.D. ϕ 4mm	360641 (w/NK10AJ)

•Hose Coupling: I.D. ϕ 4×O.D. ϕ 6mm •Piston stroke:~Max.12mm

No. NK10AJ Thrust-Cut Air Nipper blades

Plastic This is a dedicated set of blades for GT-NK10. Suitable for processing of film gates attached to robot hands.

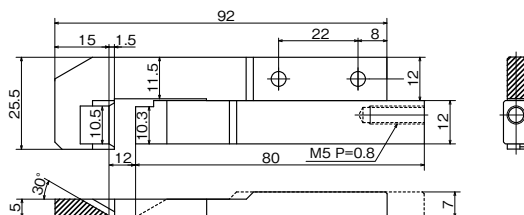

Model No.	Size (mm)	Shape	Overall Length (mm)	Weight (g)	Material	Applicable models	EDP No.
NK10AJ	See Drawing	For plastic (Knife type)	95	96	Special alloy steel	GT-NK10	—

>> For guidance on cutting capability, see P264 of the technical material.

Related product

No. GT-TC-02 Timing Controller

- Enables to adjust the sliding (nippers) and cutting timing, by installing this controller between the compressor and the air nippers. (Approximately 0.5 seconds to 1.5 seconds)

Adjusting Screw
(0.5~1.5 sec.)

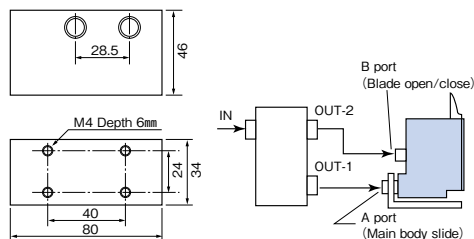

- Working air pressure:~0.6MPa
- Size:~Height 46 × Length 80 × thickness 34 (mm)
- Weight:~275g
- With tube joint: I.D. ϕ 4×O.D. ϕ 6mm

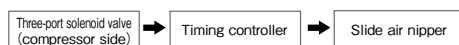

Connectable nippers(Reference)

GT-Connectable unit numbers	NY05	NY10	NY15	NY25	NT03	NT05	NT10	NT20	NB20	NB30	NB20LW	NB30LW	EDP No.
	4	3	1	1	6	4	2	1	2	1	2	1	360640

Servo Heat Nippers

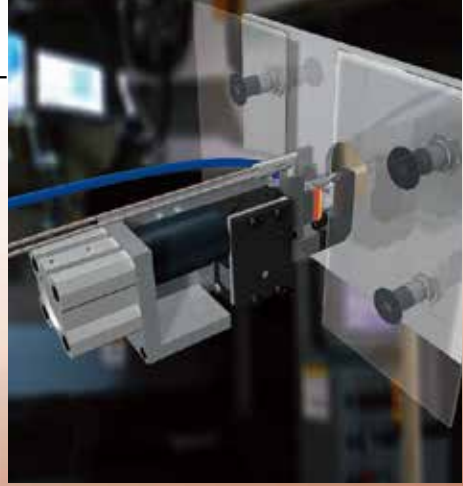

These air nippers are connected to a heater to suppress cracks and whitening of clear materials such as acrylic.

The gate is slowly melted as it's cut, resulting in a clean, unblemished cut surface.

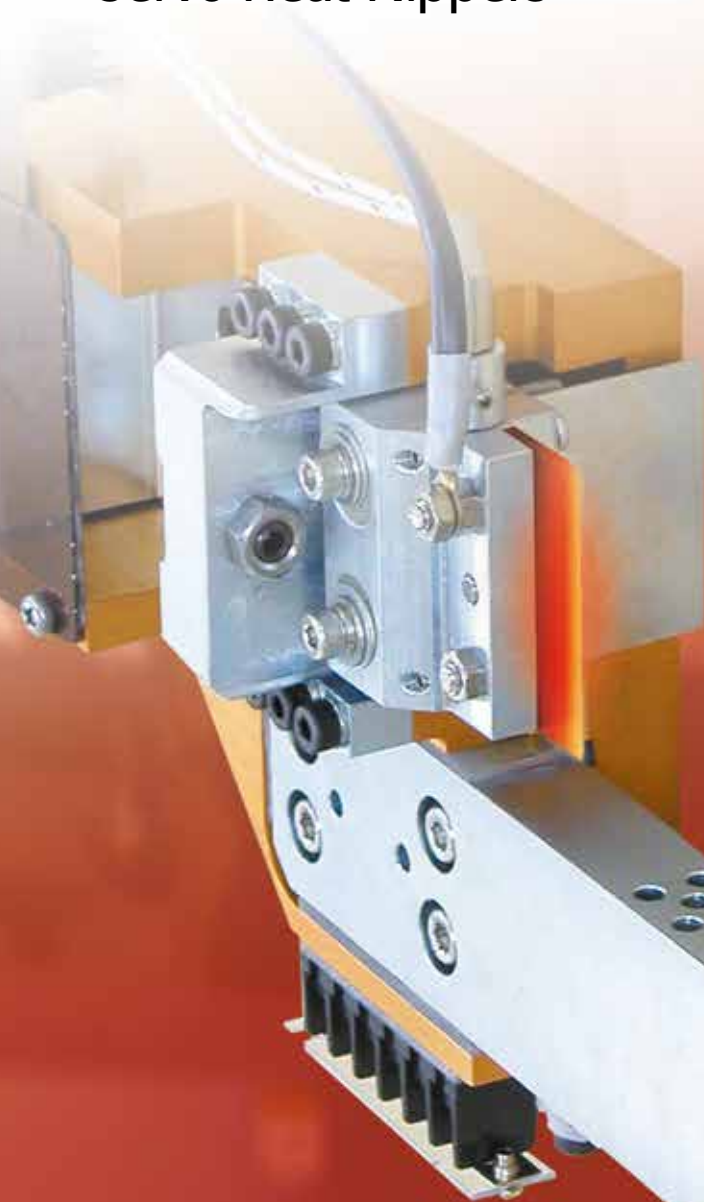

Practical example of gate-cut

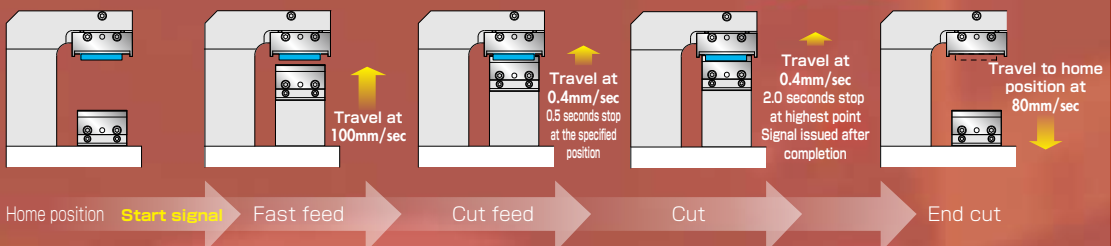

No. NKH20XL-25/NKH20XR-25

Air-Hydro Heat Nipper (thrust cut type) **NEW**

- Highly durable PTFE Plating blades; melted resin does not adhere to them.
- Improved durability of blades with high-speed chip brazed.
- Easier blade replacement than conventional models; take out the blade unit and exchange with the new one.

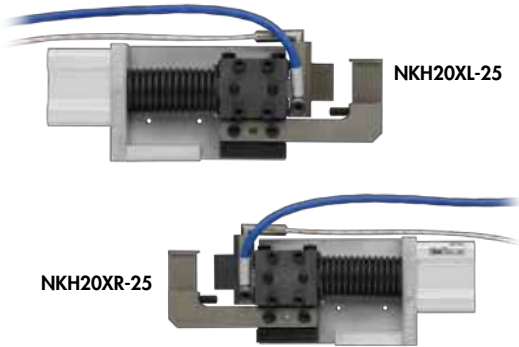

NKH20XL-25

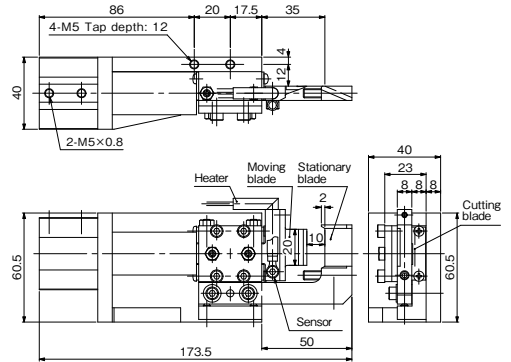

- Requires separately sold Hydro Controller.
- Custom-made blade lengths and cylinder capacities available.

Model No.	Cutting Capacity width x thickness (mm) Acril	Blade Edge Temp. (MAX °C)	Air Consumption ($\text{cm}^3/\text{str.}$)	Piston Stroke (mm)	Weight (g)	EDP No.
NKH20XL-25/ NKH20XR-25	10x1.5	180	60	10	690	—

- Working air hose inner diameter: 4 mm • Air Pressure: 0.6MPa
- The above weight is the product only. The weight of heater and sensor is not included.
- A heater for 200V AC, 220V AC, and 240V AC respectively can be made-to-order.
- The following specifications can be made on request: change in blade length; replacement of cylinder for improvement in performance; additional KINECHEK which does not require a hydro converter (oil).
- Accessory heater: HTL-28.5-6.25-300L-80W1H (80W/100V AC) Recommended operating temperature 140°C. Cord length 300mm, Weight 13g
- Accessory temperature sensor: SNO-300L-H(K thermocouple), Recommended operating temperature 140°C. Cord length 300mm, Weight 7g

NKH20XR-25

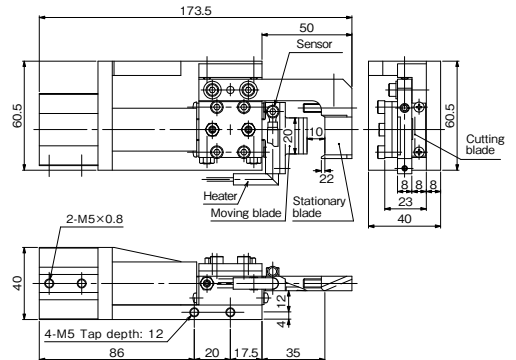

■ Blades Specifications

Material	Blade Shape	Blade Opening (mm)	Cutting blade effective (mm)	Weight (g)
Special alloy steel	Knife type (resin)	10	20	125

- Option Parts**
- Hydro-converter (Recommended: KOGANEI AHC 32x50)
Working fluid: Petroleum hydraulic fluid or turbine oil with antifoaming agent additive (VG22~100)
 - Temperature controller (DTC-001)

No. GT-NKH10 Heat Air Nippers

- Speed control of cutting speed and heater temperature allows for various cutting surface solutions and meets demands for high precision cutting result.

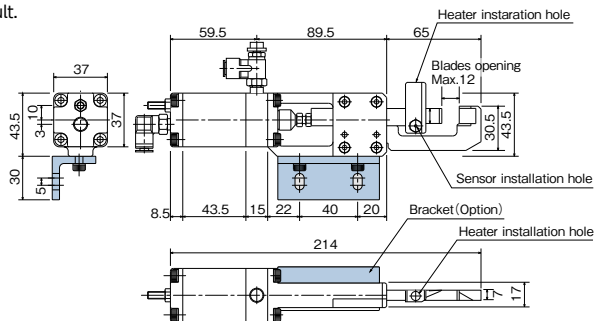

Model No.	Cutting Capacity width x thickness (mm Acrylic)	Blade Edge Temp. (MAX. °C)	Cutting Cycle (sec./cut)	Air Consumption (cm ³ /str.)	Piston Stroke (mm)	Weight (g)	EDP No.
GT-NKH10	7×1.5	200	4~5	73	12	715	360643 (w/NKH10AJ) 360644 (w/NKH10RAJ)

- Included heater
- Included temperature sensor
- Air Pressure: 0.5~0.6MPa

Blades Specifications

Model No.	Material	Blade Shape	Blade Opening (mm)	Cutting blade effective (mm)	Weight (g)	EDP No.
NKH10AJ	Special alloy steel	Knife type (resin)	12	10	137	360548
NKH10RAJ						360549

Option Parts · Temperature controller (DTC-001)

No. NTH05AJ/10AJ Heat Air Nipper Blade

- One blade is fixed in position, facilitating easy gate alignment. In addition, a slide function presses the product into position.



Example of blade mounting

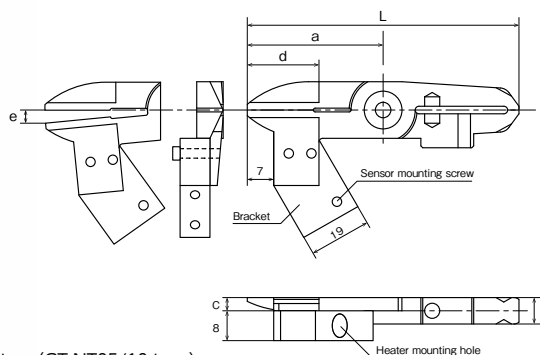

- Use these blades in combination with the Sliding Air Nippers vertical type (GT-NT05/10 type).
- For the main unit dimensions, see the Sliding Air Nippers vertical type on P214.

Model No.	Size (mm)							Weight (g)	Cutting Capacity φ (mm) Acrylic	Set temperature (MAX. °C)	Material	Applicable models	EDP No.
	a	b	c	d: Effective Length	e: Blade opening	L							
NTH05AJ	36	7	3.5	15	3.5	72	40	2.5	200	Special alloy steel	GT-NT05(-4)/GT-NT05R(-4)	360546	
NTH10AJ	47	9	4.7	17	4.5	94	88	3.5	200	Special alloy steel	GT-NT10(-6)/GT-NT10R(-6)	360547	

The above information on weight does not include heater or sensor.

The following parts are not provided; purchase them separately.

- Special heater (80 W/120 V, cord length: 300 mm), temperature sensor (type-K thermocouple, cord length: 1,000 mm), speed controller, and bracket (for heater mounting)

Option Parts · Temperature controller (DTC-001)

No. NKHD20XL-20/NKHD20XR-20 Servo Heat Nipper (With Motor Cylinder) Compact type NEW

- Blade travel distance and speed can be easily programmed.
- Servo motor ensures delicate blade feeding and quiet gate cutting.
- Improved durability of blades with high speed chip brazed.
- Easier blade replacement than conventional models; take out the blade unit and exchange with the new one.

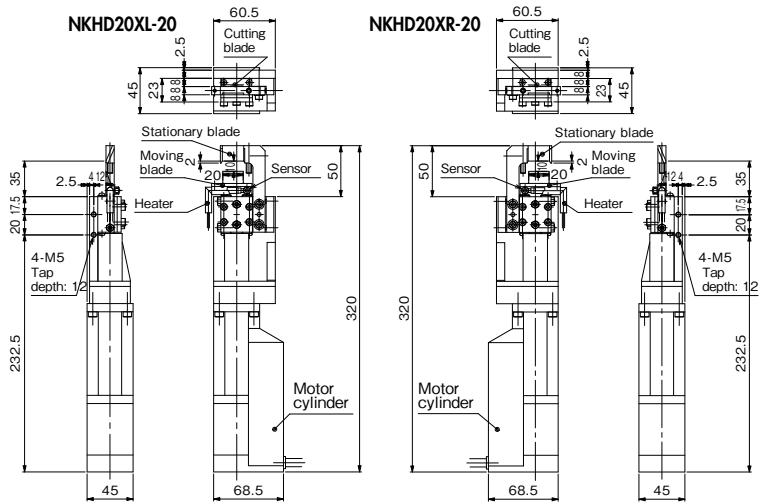

Model No.	Cutting Capacity width x thickness φ (mm) Acril	Blade Edge Temp. (MAX °C)	Blade Opening (mm)	Cutting Blade Effective (mm)	Max. Thrust (N)	Max. Speed (mm/s)	Positioning Points (pts)	Power Supply Voltage	Current consumption power	Weight (kg)	EDP No.
NKHD20XL-20 NKHD20XR-20	10×1.5	180	10	20	100	400	16	24VDC±10%	2.0A	1.57	—

※The above weight is the product only. The weight of heater and sensor is not included. ※A heater for 200V AC, 220V AC, and 240V AC, respectively can be made-to-order.
 ※The following specifications can be made on request: change in blade length, replacement of cylinder for improvement in performance, additional KINECHECK which does not require a hydro converter (oil).
 ・Accessory heater: HTL-28.5-6.25-300L-80W1H(80W/100V AC) Recommended operating temperature 140°C, Cord length 300mm, Weight 13g
 ・Accessory temperature sensor: SNO-300L-HK (thermocouple), Recommended operating temperature 140°C, Cord length 300mm, Weight 7g

Option Parts ・Temp. controller (DTC-001) ・Power supply ・Heater code ・Parallel cable ・ADP cable ・Controller (CTC-33) ・Power cord ・Sensor cord

For the options noted above, contact us because required items or the numbers of them may change depending on the installation method, use details, etc. of servo heat nippers.

HAND TOOLS

BITS & SOCKETS

ELECTRIC TOOLS

AIR TOOLS

STATIC SOLUTIONS

GASOLINE ENGINE TOOLS

No. GT-NR20

Air Nippers For Cutting and Crimping



Various models are available;
Square type for automation cutting equipment;
Round type, together with a dedicated stand,
for resin or direct gate-cutting,;
Lever type for manual operation...



No. GT-NR20

Air Nipper Round-Type without Lever

A tough body for hard jobs. The parts machined at high precision enable smooth cutting jobs to be accomplished.
With convenient scales facilitating the installation position adjustment.

HAND TOOLS

BITS & SOCKETS

ELECTRIC TOOLS

AIR TOOLS

STATIC SOLUTIONS

GASOLINE ENGINE TOOLS

No. GT-NS3/5/7/10L/20/30 Square Air Nippers

●VESSEL provides a generous selection of blades for gate-cutting of resin molded products and various wire cutting in a welding automatic machine and wire winding machine.



- The position of air intake port is 180-degree rotatable.
- Two air intake ports are provided, so they can be switched depending on the mounting place.

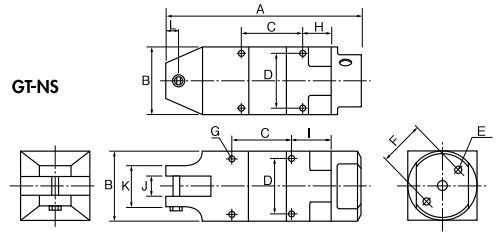

Made-to-order

GT-NS20H-1 (Blade opening adjustable)

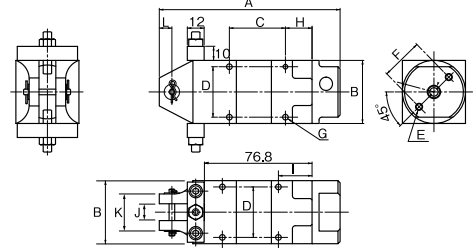

Reference

Capacity ϕ (mm) Soft Plastic Hard Plastic Copper Steel	Model No.	Size (mm)											Air Consumption (cm ³ /str.)	Air Pressure (MPa)	Weight (g)	Hose coupling	EDP No.	
		A	B	C	D	E	F	G	H	I	J	K						L
2.0 1.0 0.5	GT-NS3	110	23	40	19	M3 Depth8	17	M3 Depth3.5	19	24	7	23	7	45	0.4~0.5	95	Rc 1/8	360012
2.0 1.0 0.5	GT-NS5	94	30	30	24	M4 Depth10	20	M3 Depth5	14	19	7	23	7	64	0.4~0.5	135		360013
3.0 2.0 1.6 1.0	GT-NS7	113	36	30	28	M4 Depth10	24	M4 Depth5.5	18	23	9	23	7	116	0.4~0.5	215		360014
4.0 2.6 1.8 1.2	GT-NS10L	113	36	30	28	M4 Depth10	24	M4 Depth5.5	18	23	12	26	7	116	0.5~0.6	215		360009
7.0 5.0 2.6 2.0	GT-NS20	129	45	40	36	M5 Depth12	30	M4 Depth7	19	24	12	26	9	230	0.5~0.6	370		360010
10.0 6.5 3.3 2.8	GT-NS30	170	56	60	46	M6 Depth12	40	M5 Depth10	20	30	17	36	15	584	0.5~0.6	685		360011
7.0 5.0 2.6 2.0	GT-NS20H-1	129	45	40	36	M5 Depth12	30	M4 Depth7	19	24	12	26	9	230	0.5~0.6	455		360021

※The capacity in the above table is given for reference, when mounting a standard type of blade.
The capacity depends on the blade shape and the material of the object to cut.
•Air hose inner dia. : 5mm •Overall length and Weight: Accessories not included.

• Check the dimensions of the VESSEL nippers and blades when installing them in an automation machine (outer diameter of the frame, screw diameter, distance between installation screws, and others)
• The GT-NS50 is available as made-to-order. Please consult us for more detail.

No. GT-N3/5/7/10/12/20/30/50 Hand Held Air Nippers

●VESSEL's made-to-order blades provide solutions for a virtually unlimited range of needs, leading to safer and more efficient working conditions, and less fatigue for the operator.



•N20, N30 and N50 have the air cock.

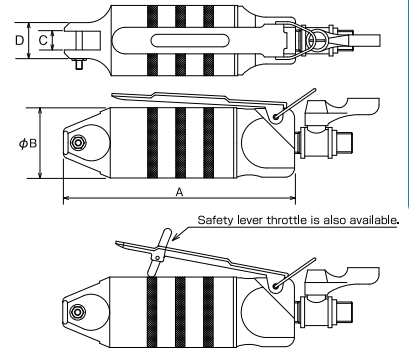

Reference

Capacity ϕ (mm) Soft Plastic Hard Plastic Copper Steel	Model No.	Size (mm)				Air Consumption (cm ³ /str.)	Air Pressure (MPa)	Weight (g)	Body	Hose coupling	EDP No.
		A	B	C	D						
2.0 1.0 0.5	GT-N3	112	23	7	14	45	0.4~0.5	95	Rc 1/8	Rc 1/4	360002
2.0 1.0 0.5	GT-N5	103	30	7	17	64	0.4~0.5	135	Rc 1/8		360003
3.0 2.0 1.6 1.0	GT-N7	123	34	9	17	116	0.4~0.5	180	Rc 1/4		360004
4.0 2.6 1.8 1.2	GT-N10	132	34	9	17	116	0.4~0.5	185	Rc 1/4		360005
4.5 4.0 2.3 1.7	GT-N12	142	36	12	20	116	0.5~0.6	210	Rc 1/4		360006
7.0 5.0 2.6 2.0	GT-N20	148	45	12	23	230	0.5~0.6	375	Rc 1/4		360007
10.0 6.5 3.3 2.8	GT-N30	185	56	17	30	584	0.5~0.6	625	Rc 1/4		360008
5.5 4.5	GT-N50	237	75	25.2	43	1,170	0.5~0.6	1,220	Rc 1/4		360001

※The capacity in the above table is given for reference, when mounting a standard type of blade. The capacity depends on the blade shape and the material of the object to cut.
•Hose coupling: Rc1/4 •Air hose inner dia. : 5mm •Overall length: Accessories, Hunger not included. •Weight: Accessories not included.

※Blades are optional.

HAND TOOLS

BITS & SOCKETS

ELECTRIC TOOLS

AIR TOOLS

STATIC SOLUTIONS

GASOLINE ENGINE TOOLS

No. GT-NR3/5/7/10L/20/30/50 Air Nipper Round-Type without Lever

- The position of air intake port is 180-degree rotatable.
- Two air intake ports are provided, so they can be switched depending on the mounting place.

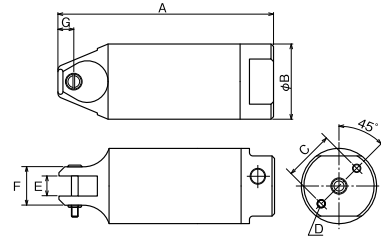

Reference

Capacity ϕ (mm)				Model No.	Size (mm)							Air Consumption (ml/str.)	Air Pressure (MPa)	Weight (g)	Hose coupling	EDP No.
Soft Plastic	Hard Plastic	Copper	Steel		A	B	C	D	E	F	G					
2.0	1.0	0.5		GT-NR3	110	23	17	M3 Depth8	7	14	7	45	0.4~0.5	70	Rc 1/8	360015
2.0	1.0	0.5		GT-NR5	94	30	20	M4 Depth10	7	17	7	64	0.4~0.5	110		360016
3.0	2.0	1.6	1.0	GT-NR7	113	34	22	M4 Depth10	9	17	7	116	0.4~0.5	150		360017
4.0	2.6	1.8	1.2	GT-NR10L	113	36	24	M4 Depth10	12	20	7	116	0.5~0.6	215		360018
7.0	5.0	2.6	2.0	GT-NR20	129	45	30	M5 Depth12	12	23	9.5	230	0.5~0.6	280		360019
10.0	6.5	3.3	2.8	GT-NR30	165	56	40	M6 Depth12	17	30	10.5	584	0.5~0.6	505		360020
12.0	6.5	5.5	4.5	GT-NR50	222	75	50	M8 Depth12	25.2	43	15	1,170	0.5~0.6	1,190	Rc 1/4	360024

*The capacity in the above table is given for reference, when mounting a standard type of blade.
The capacity depends on the blade shape and the material of the object to cut.
*Air hose inner dia.: 5mm *Overall length and Weight: Accessories not included.

*Before mounting on dedicated/automatic machines, check the following product dimensions.
(Flame O.D., screw dia, (screw to screw) dimensions, etc.)
*Capacity (ϕ) is for reference purpose only. It varies depending on products.

No. NR10LST/20ST/30ST/50ST Stand for GT-NR

- Fixing hardware for sprue cutting of direct gates or mounting to an automatic machine.
- Mounted angle can be adjusted (0 to 60°).



Mounting example

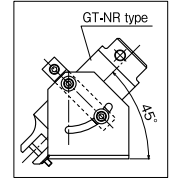

Model No.	Size (mm)				Weight (g)	EDP No.
	A	B	C	D		
NR10LST	102	52	36	84	335	360057
NR20ST	110	60	45	92	385	360058
NR30ST	130	80	56	112	535	360059
NR50ST	150	100	75	132	835	852436

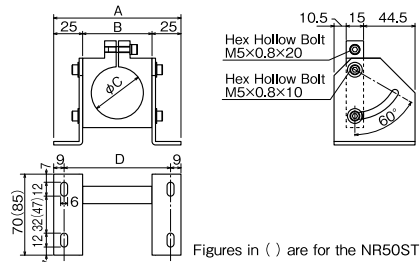

Figures in () are for the NR50ST

No. P-10L/20/30/50 Extra Pressure Boosters

- This unit is to be used in case the originally required pressure is not obtainable by the limit of space and air pressure.

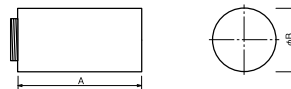

Reference

Capacity ϕ (mm)				Applicable models	Model No.	Size (mm)		Air Consumption (ml/str.)	Air Pressure (MPa)	Weight (g)	EDP No.
Soft Plastic	Hard Plastic	Copper	Steel			A	B				
5.0	4.0	2.6	1.6	NS10L, NR10L, N12	P-10L	71	36	223	Up to 0.5MPa	115	360051
8.0	6.0	3.0	2.2	N20, NS20, NR20	P-20	87	45	508	Up to 0.5MPa	215	360052
13.0	7.0	4.8	4.0	N30, NS30, NR30	P-30	92	56	956	Up to 0.5MPa	330	360053
6.5	5.5			N50, NR50	P-50	133	75	2,670	Up to 0.5MPa	840	360054

*The capacity in the above table is given for reference, when mounting a standard type of blade. The capacity depends on the blade shape and the material of the object to cut.
*Above figures of overall length and the weight are defined for the extra booster specs only. And these figures in the installation.

※Blades are optional.

No. GT-NWR10/20/30 GT-NWS1/10/20/30 Double Action Air Nippers

- Blade opening and closing is driven by air piston.
- Having no spring mechanism in the main unit facilitates maintenance.

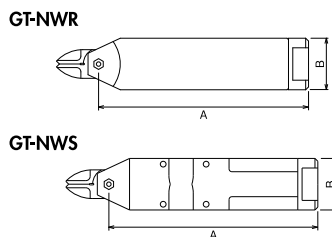

Model No.	Capacity ϕ (mm)			Air Consumption (cm ³ /str.)	Applied Pressure (N)	Air Pressure (MPa)	Size (mm)		Weight (g)	EDP No.
	Copper	Steel	ABS Plastic				A	B		
Double Action Air Scissors (Round Type without Lever)										
GT-NWR10	1.8	1.2	4.0	116	588	0.4~0.5	146	ϕ 36	280	360710
GT-NWR20	2.6	2.0	6.5	230	1,372	0.5~0.6	165	ϕ 45	523	360711
GT-NWR30	3.3	2.8	9.5	584	2,744	0.5~0.6	216	ϕ 56	980	360712
Double Action Air Scissors (Square Type)										
GT-NWS1	1.0	0.5	2.0	45	294	0.4~0.5	95	23×20	116	360702
GT-NWS10	1.8	1.2	4.0	116	588	0.4~0.5	146	36×36	356	360706
GT-NWS20	2.6	2.0	6.5	230	1,372	0.5~0.6	165	45×45	610	360707
GT-NWS30	3.3	2.8	9.5	584	2,744	0.5~0.6	230.5	56×56	1,115	360708

NEW

No. GT-NB20/30/20LW/30LW

Sliding Air Nippers Bracket-Type

- VESSEL has achieved smooth and continuous slide movement even for large diameter gate cuts, which produces a large shock at each cut.



GT-NB20LW-10TM
Slide Mechanism Accurate Model

GT-NB20

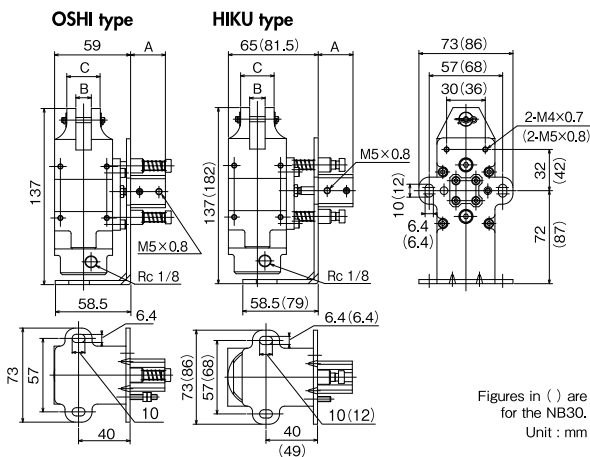

Figures in () are for the NB30.
Unit : mm

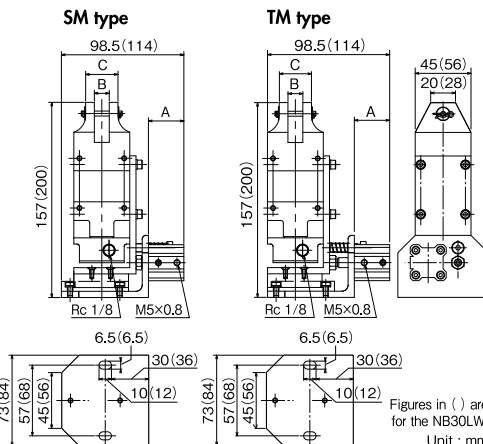

Figures in () are for the NB30LW.
Unit : mm

Model No.	Dimensions (mm)			Slide Direction/ Distance (mm)	Weight (g)	EDP No.
	A	B	C			
GT-NB20(5-OSHI)	22	12	26	Push 0~5	755	360073
GT-NB20(5-HIKU)	22	12	26	Pull 0~5	755	360071
GT-NB20(10-OSHI)	27	12	26	Push 0~10	755	360074
GT-NB20(10-HIKU)	27	12	26	Pull 0~10	755	360072
GT-NB30(10-HIKU)	28.5	17	36	Pull 0~10	1,420	360076
GT-NB20LW-10TM	28.5	12	26	Pull 0~10	795	360069
GT-NB30LW-10TM	29.5	17	36	Pull 0~10	1,315	360077
GT-NB20LW-10SM	28.5	12	26	Push 0~10	795	360068
GT-NB30LW-10SM	29.5	17	36	Push 0~10	1,325	360078

No. AS/HS Standard



AS/Standard type. Basic set of blades used for cutting copper wire and steel wire.
HS/Improved durability with brazed high-speed steel.

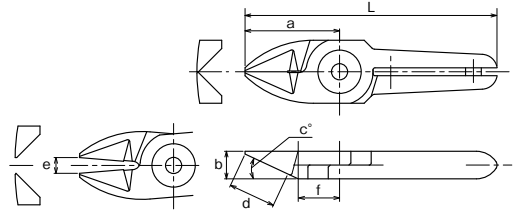

Model No.	Size (mm)							Weight (g)	Material	Applicable models	EDP No.
	a	b	c(°)	d: Effective Length	e: Blade opening	f	L				
N3AS	24	7	25	12	4	10.5	64	35	Special alloy steel	GT-NS3 / N3 / NR3	360102
N3HS	24	7	25	12	4	10.5	64	35	w/High speed steel chip	GT-NS3 / N3 / NR3	360101
N5AS	24	7	25	12	4	10.5	64	40	Special alloy steel	GT-NS5 / N5 / NR5	360112
N5HS	24	7	25	12	4	10.5	64	40	w/High speed steel chip	GT-NS5 / N5 / NR5	360111
N7AS	27	9	30	13.5	4	12.5	81	80	Special alloy steel	GT-NS7 / N7 / NR7	360122
N7HS	27	9	30	13.5	4	12.5	81	80	w/High speed steel chip	GT-NS7 / N7 / NR7	360121
N10AS	27	9	30	13.5	5	12.5	91	85	Special alloy steel	GT-N10	360132
N10HS	27	9	30	13.5	5	12.5	91	85	w/High speed steel chip	GT-N10	360131
N10LAS	35	12	30	20	5	15	89	120	Special alloy steel	GT-NS10L / NR10L	360181
N12AS	35	12	30	20	5	15	105	135	Special alloy steel	GT-N12	360142
N12HS	35	12	30	20	5	15	105	135	w/High speed steel chip	GT-N12	360141
N20AS	35	12	30	20	9	15	95	140	Special alloy steel	GT-NS20 / N20 / NR20 / NB20	360151
N30AS	43	17	30	25	9	18	127	370	Special alloy steel	GT-NS30 / N30 / NR30 / NB30	360161

>> For guidance on cutting capability, see P264 of the technical material.

No. BJ Straight blades for metals



BJ/This is a set of vertical blades with an unbeveled cutting edge for metal.

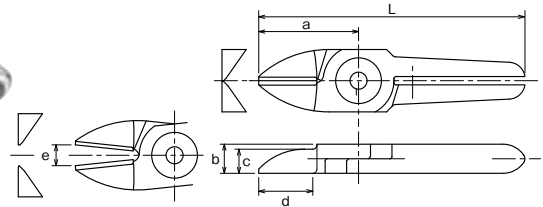

Model No.	Size (mm)							Weight (g)	Material	Applicable models	EDP No.
	a	b	c	d: Effective Length	e: Blade opening	L					
NW1BJ	20	5	3	10.5	3.5	50	16	Special alloy steel	GT-NWR1 / NWS1	360450	
N3BJ	24	7	5.8	13	5	64	35	Special alloy steel	GT-NS3 / N3 / NR3	360106	
N5BJ	24	7	5.8	13	4	64	40	Special alloy steel	GT-NS5 / N5 / NR5	360119	
N7BJ	27	9	7.5	13	5	81	75	Special alloy steel	GT-NS7 / N7 / NR7	360128	
NW10BJ*	30	9	6	14	5	85	76	Special alloy steel	GT-NWR10 / NWS10	360453	
NW20BJ*	40	12	6	21.5	8	100	142	Special alloy steel	GT-NWR20 / NWS20	360459	
NW30BJ*	55	17	8	29.5	11	140	367	Special alloy steel	GT-NWR30	360460	

*Subject to change in the blade tip specifications (NW types only). See P204.

>> For guidance on cutting capability, see P264 of the technical material.

No. AG Powerful cutting blades



AG/This is a set of blades with increased strength with a shorter cutting edge than the standard type. More welding pressure is created because it cuts at the base of the blades.

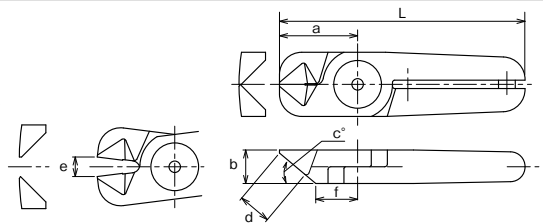

Model No.	Size (mm)							Weight (g)	Material	Applicable models	EDP No.
	a	b	c(°)	d: Effective Length	e: Blade opening	f	L				
N20AG	28	12	40	12	7	15	88	135	Special alloy steel	GT-NS20 / N20 / NR20 / NB20	360159
N20HS	26	12	40	10	7	13.5	86	135	w/High speed steel chip	GT-NS20 / N20 / NR20 / NB20	360157

>> For guidance on cutting capability, see P264 of the technical material.

No. BBB Powerful cutting blades with carbide chip



BBB/With carbide chip suitable for cutting hard wires such as high steel wire and piano wire.



Carbide chip
 Recommended to the applications where more durable blade than the special alloy steel is required (i.e. when cutting piano wires)

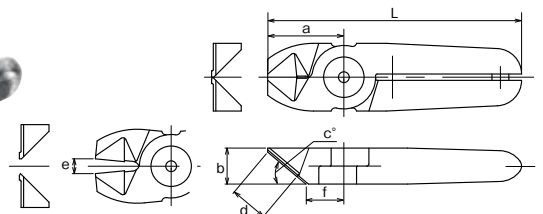

Model No.	Size (mm)							Weight (g)	Material	Applicable models	EDP No.
	a	b	c(°)	d: Effective Length	e: Blade opening	f	L				
N30BBB	36	17	40	18	7	18	120	365	w/Carbide chip	GT-NS30 / N30 / NR30 / NB30	360172
N50BBB	46	25	35	19	9	24	166	955	w/Carbide chip	GT-N50 / NR50	360177

>> For guidance on cutting capability, see P264 of the technical material.

HAND TOOLS

BITS & SOCKETS

ELECTRIC TOOLS

AIR TOOLS

STATIC SOLUTIONS

GASOLINE ENGINE TOOLS

Air nipper standard blades for metal

No. BFB/AS Clipper blades with carbide chip

Metal BFB/With carbide chip, suitable for cutting metal wire and thin pipe.
AS/Standard clipper type blades.



N50AS

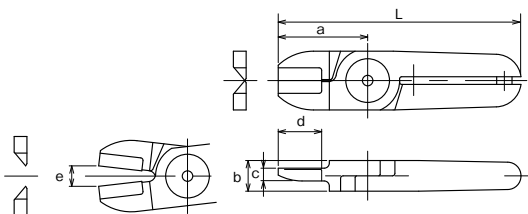
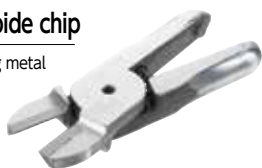

Model No.	Size (mm)						Weight (g)	Material	Applicable models	EDP No.
	a	b	c	d: Effective Length	e: Blade opening	L				
N20BFB	35	12	5	17	8	95	150	w/Carbide chip	GT-NS20 / N20 / NR20 / NB20	360156
N50AS	60	25	10	30	11	180	950	Special alloy steel	GT-N50 / NR50	360175

>> For guidance on cutting capability, see P264 of the technical material.

No. ACD Crimp edge for solderless terminals

Metal ACD/This is a set of blades for crimping solderless terminals.
 (Bare terminal 1.25sq/2.0sq)

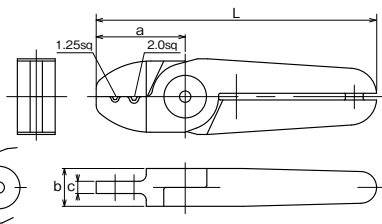

Model No.	Size (mm)					Weight (g)	Material	Applicable models	EDP No.
	a	b	c	e: Blade opening	L				
N30ACD	40	17	5.5	8	126	335	Special alloy steel	GT-NS30 / N30 / NR30 / NB30	360171

>> For guidance on cutting capability, see P264 of the technical material.

Air nipper standard blades for plastic

No. NM NM Blades

PAT.

NM blades eliminate troubles caused by spring breakage. Can be mounted on the VESSEL current air nippers. Periodic replacement of spring is no more necessary as the magnet works semi-permanently.



- Ideal for around-the-clock operations
- Semi-permanent magnetic force
- Compatible with our standard nipper bodies

Thin, straight type / For plastic parts

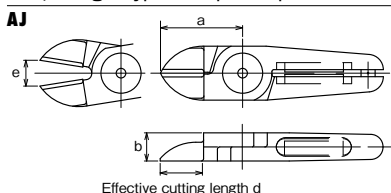

For plastic parts

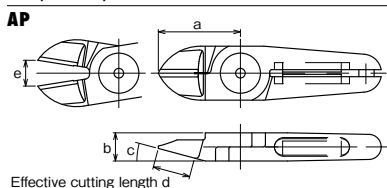

Nipping type / For plastic parts

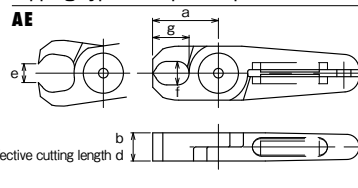

Model No.	Size (mm)						Weight (g)	Applicable models	EDP No.
	a	b	c(*)	d	e	f×g			
NM20AJ	35	12	-	18	11	-	116	GT-NS20 / N20 / NR20 / NB20	360246
NM20AP	35	12	15	16	11	-	124	GT-NS20 / N20 / NR20 / NB20	360247
NM20AE	28	12	-	12	8	10×15.5	129	GT-NS20 / N20 / NR20 / NB20	360248
NM30AJ	52	17	-	28	11	-	360	GT-NS30 / N30 / NR30 / NB30	360261
NM30AP	66	17	15	38	16	-	380	GT-NS30 / N30 / NR30 / NB30	360262
NM30AE	45	17	-	17	12	13×28	358	GT-NS30 / N30 / NR30 / NB30	360263

>> For guidance on cutting capability, see P264 of the technical material.

*Customization also available upon request.

CAUTION
 Powerful magnet is used.

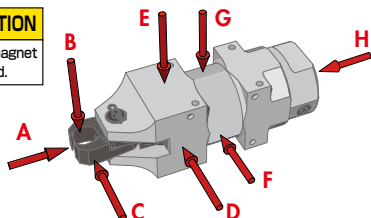

Result of magnetic force measurement

If a magnetic sensor for operation check is installed nearby, please confirm the magnetic force level in the following diagram.

品番No.	A	B	C	D	E	F	G	H	EDP No.
NM20AE	85	10	10	5	32	5	2	0	360248
NM30AE	34	8	8	6	42	15	30	3	360263

Measurement unit: Gauss
 Measurement device: Gaussmeter GM-1200 manufactured by DENSHIUKI INDUSTRY Co., Ltd.

No. AP Standard blades for plastic

Plastic **AP**/Standard set of blades used to cut plastic. A wide curve shape on the cutting surface makes this blade suitable for the gate cutting process in which the cut end must not be left.

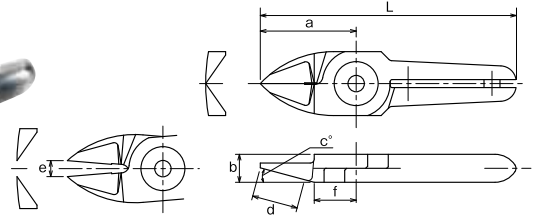

Model No.	Size (mm)							Weight (g)	Material	Applicable models	EDP No.
	a	b	c(*)	d: Effective Length	e: Blade opening	f	L				
N3AP	24	7	15	11.5	4	10.5	64	35	Special alloy steel	GT-NS3 / N3 / NR3	360104
N5AP	24	7	15	11.5	4	10.5	64	40	Special alloy steel	GT-NS5 / N5 / NR5	360114
N7AP	27	9	30	11.5	4	14.5	81	80	Special alloy steel	GT-NS7 / N7 / NR7	360124
N10AP	27	9	30	11.5	5	14.5	91	85	Special alloy steel	GT-N10	360134
N10LAP	35	12	15	16	5	15	89	120	Special alloy steel	GT-NS10L / NR10L	360182
N12AP	35	12	15	16	5	15	105	135	Special alloy steel	GT-N12	360144
N20AP	35	12	15	16	11	15	95	125	Special alloy steel	GT-NS20 / N20 / NR20 / NB20	360155
N30AP	66	17	15	38	16	24	150	380	Special alloy steel	GT-NS30 / N30 / NR30 / NB30	360165

>> For guidance on cutting capability, see P264 of the technical material.

No. AE Nipping blades for plastic

Plastic **AE**/Used for plastic gates such as ride gates and discard gates.

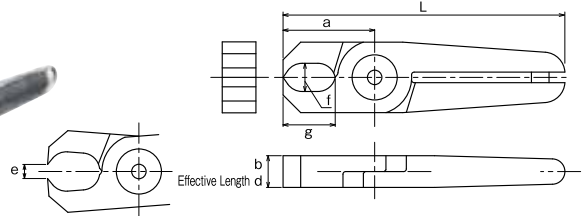
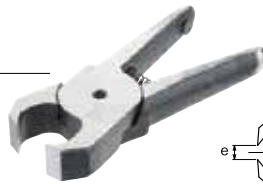

Model No.	Size (mm)						Weight (g)	Material	Applicable models	EDP No.
	a	b	f×g	d: Effective Length	e: Blade opening	L				
N3AE	20	7	6x11	7	3.5	60	35	Special alloy steel	GT-NS3 / N3 / NR3	360108
N5AE	20	7	6x6.6	7	3.5	60	40	Special alloy steel	GT-NS5 / N5 / NR5	360118
N7AE	26	9	8x14.8	9	4	80	85	Special alloy steel	GT-NS7 / N7 / NR7	360126
N20AE	28	12	10x15.5	12	8	88	135	Special alloy steel	GT-NS20 / N20 / NR20 / NB20	360158
N30AE	45	17	13x28	17	12	129	395	Special alloy steel	GT-NS30 / N30 / NR30 / NB30	360166

>> For guidance on cutting capability, see P264 of the technical material.

No. AJ Straight blades for plastic

Plastic **AJ**/Vertical blades with an unbeveled cutting edge for plastic. You can apply it at a right angle to the gate.

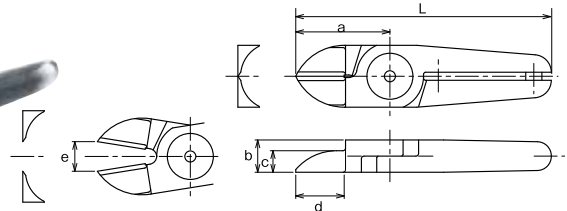

Model No.	Size (mm)							Weight (g)	Material	Applicable models	EDP No.
	a	b	c	d: Effective Length	e: Blade opening	L					
NW10AJ*	30	9	6	14	5	85	76	Special alloy steel	GT-NWR10 / NWS10	360454	
N20AJ	35	12	8	18	11	95	125	Special alloy steel	GT-NS20 / N20 / NR20 / NB20	360152	
N20AJB	35	12	8	18	11	95	125	w/Carbide chip	GT-NS20 / N20 / NR20 / NB20	360381	
NW20AJ*	40	12	6	21.5	8	100	142	Special alloy steel	GT-NWR20 / NWS20	360457	
N30AJ	52	17	8	28	14.5	136	370	Special alloy steel	GT-NS30 / N30 / NR30 / NB30	360169	
NW30AJ*	55	17	8	29.5	11	140	368	Special alloy steel	GT-NWR30	360461	

*Subject to change in the blade tip specifications (NW types only). See P204.

>> For guidance on cutting capability, see P264 of the technical material.

No. AJL Quasi-standard products Straight long blades for plastic

Plastic **AJL**/Long type straight blades. Suitable when there is distance between the nippers and the gate cut portion of the workpiece. N30AJL163 is useful for cutting wide gates.

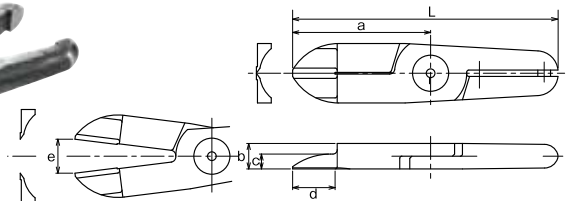

Model No.	Size (mm)							Weight (g)	Material	Applicable models	EDP No.
	a	b	c	d: Effective Length	e: Blade opening	L					
※ N10LAJ141	61	12	7	34	10	115	165	Special alloy steel	GT-NS10L / NR10L	360369	
N20AJL	65	12	7	20	16	125	230	Special alloy steel	GT-NS20 / N20 / NR20 / NB20	360150	
※ N20AB39	61	12	7	36	14	121	185	Special alloy steel	GT-NS20 / N20 / NR20 / NB20	360376	
※ N30AJ163	65	17	7	41	17.5	149	355	Special alloy steel	GT-NS30 / N30 / NR30 / NB30	360389	
N30AJL	75	17	8	25	19	159	470	Special alloy steel	GT-NS30 / N30 / NR30 / NB30	360170	

>> For guidance on cutting capability, see P264 of the technical material.

Blade with a mark ※ is a quasi-standard.

HAND TOOLS

BITS & SOCKETS

ELECTRIC TOOLS

AIR TOOLS

STATIC SOLUTIONS

GASOLINE ENGINE TOOLS

No. PF Flat blades for plastic

Plastic **PF/A** set of blades for cutting plastic gates with cutting end flat. A wide curve shape on the cutting surface makes this blade suitable for the gate cutting process in which the cut end must not be left.

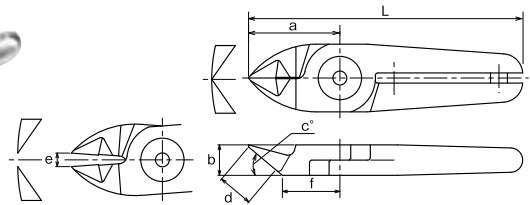

Model No.	Size (mm)							Weight (g)	Material	Applicable models	EDP No.
	a	b	c (°)	d: Effective Length	e: Blade opening	f	L				
N7PF	27	9	40	10.5	4	17	81	80	Special alloy steel	GT-NS7 / N7 / NR7	360127
N10LPF	35	12	40	13.5	5	21	89	120	Special alloy steel	GT-NS10L / NR10L	360183
N20PF	35	12	40	13.5	11	21	95	130	Special alloy steel	GT-NS20 / N20 / NR20 / NB20	360160
N30PF	58	17	30	25	15	33	142	390	Special alloy steel	GT-NS30 / N30 / NR30 / NB30	360167

>> For guidance on cutting capability, see P264 of the technical material.

No. Quasi-standard products AH Crank blades for plastic

Plastic **AH**/Crank shaped blade for plastic. It is effective when there are obstructions or the gate is narrow.

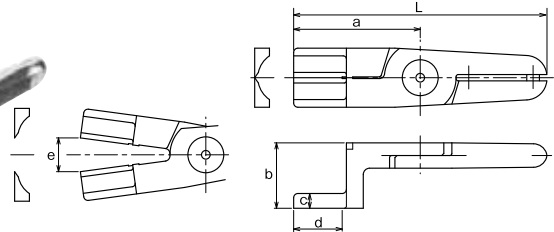
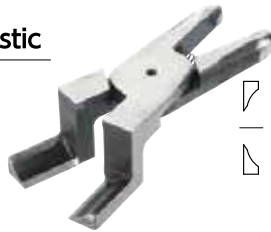

Model No.	Size (mm)							Weight (g)	Material	Applicable models	EDP No.
	a	b	c	d: Effective Length	e: Blade opening	L					
N20AH	60	31	7	23	16	120	240	Special alloy steel	GT-NS20 / N20 / NR20 / NB20	360149	

>> For guidance on cutting capability, see P264 of the technical material.

No. Quasi-standard products AML/AMR Laterally facing blades for plastics

Plastic **AML/AMR** This is a set of blades for plastic where the cutting area is bent 90 degrees. It is useful when it is hard for the nipper to get into, for example, in cramped spaces.

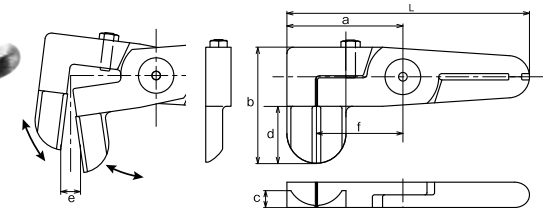

Model No.	Size (mm)							Weight (g)	Material	Applicable models	EDP No.
	a	b	c	d: Effective Length	e: Blade opening	f	L				
N20AML1498	55	55	8	26	9.5	41	115	270	Special alloy steel	GT-NS20 / N20 / NR20 / NB20	360384
N20AMR1499	55	55	8	26	9.5	41	115	270	Special alloy steel	GT-NS20 / N20 / NR20 / NB20	360385
NEW N30AML1435	55	68	10	35	13	39	139	520	Special alloy steel	GT-NS30 / N30 / NR30 / NB30	360370
NEW N30AMR1395	55	68	10	35	13	39	139	520	Special alloy steel	GT-NS30 / N30 / NR30 / NB30	360371

>> For guidance on cutting capability, see P264 of the technical material.

No. Quasi-standard products AE Nipping blades for plastic **NEW**

Plastic **AE**/Used for plastic gates such as ride gates and discard gates.

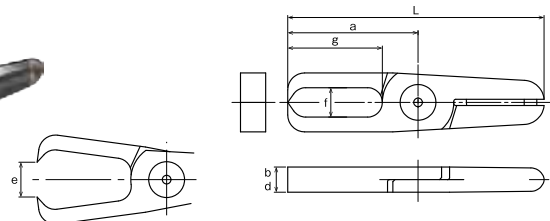

Model No.	Size (mm)							Weight (g)	Material	Applicable models	EDP No.
	a	b	f×g	d: Effective Length	e: Blade opening	L					
N20AE1205	62	12	14×45	12	16.5	122	202	Special alloy steel	GT-NS20 / N20 / NR20 / NB20	360378	
N30AE1215	70	17	16×53	17	19.5	154	385	Special alloy steel	GT-NS30 / N30 / NR30	360173	

>> For guidance on cutting capability, see P264 of the technical material.

No. Quasi-standard products **R blades for plastic**

Plastic A large R is provided in the cross section for gate processing where the cut end must not be left. An angled blade can be selected in accordance with the installation angle of the main unit.

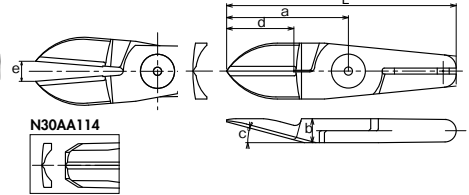

Model No.	Size (mm)						Weight (g)	Material	Applicable models	EDP No.
	a	b	c (°)	d: Effective Length	e: Blade opening	L				
N10LAB152	61	12	15	35	10	115	165	Special alloy steel	GT-NS10 / NR10L	360367
N20AA27	45	12	23	25	12	105	145	Special alloy steel	GT-NS20 / N20 / NR20 / NB20	360373
N20AA239	52.3	12	40	27	14	112.3	195	Special alloy steel	GT-NS20 / N20 / NR20 / NB20	360372
N20AB360	61	12	15	35	16	121	185	Special alloy steel	GT-NS20 / N20 / NR20 / NB20	360375
N30AA114	76.3	17	30	50	20	160.3	385	Special alloy steel	GT-NS30 / N30 / NR30 / NB30	360386

>> For guidance on cutting capability, see P264 of the technical material.

No. Quasi-standard products **Nipping blades for plastic**

Plastic **AE/**Used for plastic gates such as ride gates and discard gates.

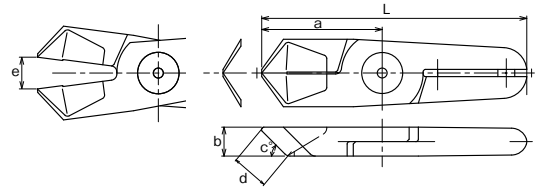

Model No.	Size (mm)						Weight (g)	Material	Applicable models	EDP No.
	a	b	c (°)	d: Effective Length	e: Blade opening	L				
N20AE19A	50	12	45	13	13	110	200	Special alloy steel	GT-NS20 / N20 / NR20 / NB20	360382
N30AE53	65	17	65	18.5	16	149	440	Special alloy steel	GT-NS30 / N30 / NR30 / NB30	360388

>> For guidance on cutting capability, see P264 of the technical material.

No. Quasi-standard products **Nipping blade for pin gates**

Plastic Suitable for cutting a pin gate at its bottom that is located in a hollow space.

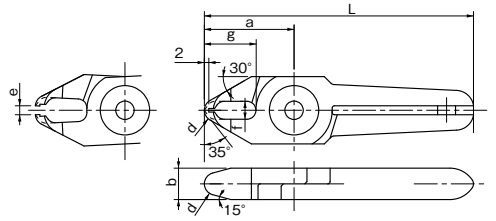

Model No.	Size (mm)						Weight (g)	Material	Applicable models	EDP No.
	a	b	d	f×g	e: Blade opening	L				
N3AE406	20	7	R2.5	4×11.5	3.5	60*	34	Special alloy steel	NS3H-1* / N3 / NS3 / NR3	360174

>> For guidance on cutting capability, see P264 of the technical material.

* Custom-made nipper model GT-NS3H-1 (the blade opening is adjustable) is recommended for the application that the blade should be inserted to a deep area.

No. Quasi-standard products **Nipping blades for sprue cut**

Plastic Perfect spherical set of blades optimal for cutting sprue. The blades can be inserted securely to narrow spaces that have ribs around them and the finish is very clean.

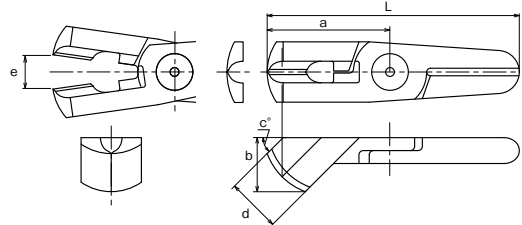

Model No.	Size (mm)						Weight (g)	Material	Applicable models	EDP No.
	a	b	c	d: Effective Length	e: Blade opening	L				
N20AK249	57	25	45	25	14	117	240	Special alloy steel	GT-NS20 / N20 / NR20	360383

>> For guidance on cutting capability, see P264 of the technical material.

No. Quasi-standard products **L blades for sprue cut**

Plastic This is an angled long type straight set of blades with a 90-degree angle. Ideal for direct gate cut.

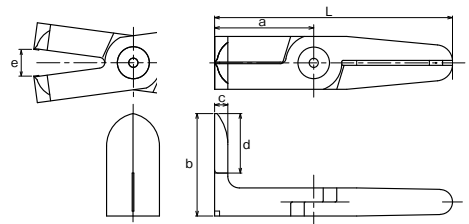

Model No.	Size (mm)						Weight (g)	Material	Applicable models	EDP No.
	a	b	c	d: Effective Length	e: Blade opening	L				
N30AL525	60	62	8	36	16	144	520	Special alloy steel	GT-NS30 / N30 / NR30 / NB30	360390

>> For guidance on cutting capability, see P264 of the technical material.

No. GT-H12K/H30/H120K/HS30 Air Scissors

- Two types of blades, standard and micro-edge, are available.



GT-H12K Small lightweight type with one fixed blade (Made-to-order)

GT-H120K With one fixed blade



GT-H30 Round-Type Double movable blades

GT-HS30 Square-Type Double movable blades

Model No.	Capacity (max) (mm)	Air Consumption (cm ³ /str.)	Applied Pressure (MPa)	Overall Length (with Blade) (mm)	Weight (with Blade) (g)	EDP No.
GT-H30	Kevlar t=1	584	0.3	280	1,030	360211
GT-H12K	Kevlar t=0.3	116	0.2	186.2	290	360201
GT-H120K	Band steel 15x0.5t	116	0.5~0.6	211	340	360202
GT-HS30	Kevlar t=1	584	0.3	260	970	360212

· Hose coupling: R1/4 (Body Rc1/8) · Air hose inner dia.: 5 mm · Overall length/Weight: Accessories not included.
 · Total length and weight of the GT-HS30 and HS30 are given with the H30ME blade mounted.

※Blades are optional.

Blades specifications

Model No.	Applicable Nippers	Blade Shape	Blade Aperture (mm)	Effective Blade Cutting Length (mm)	Weight (g)	EDP No.
H30ME	H30,	Scissors type	26	50	280	360311
H30MEL	HS30	Serrated micro edge	34	67	285	360312
H12ME30K	H12K	Scissors type	17	28	56	360301
H120SK	H120K	Scissors type	15	38	115	360302



Serrated micro edge

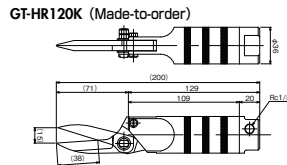
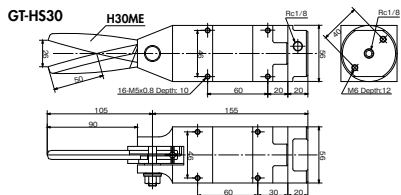
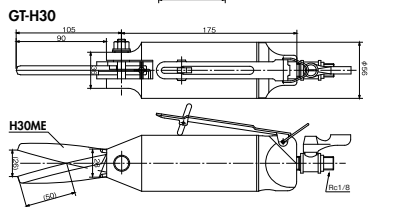
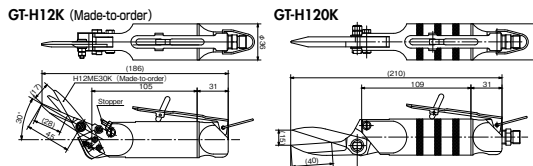

No. GT-HWR1/10 GT-HWS1/10 Double Action Air Scissors

- Blade opening and closing is driven by air piston.
- Having no spring mechanism in the main unit facilitates maintenance.



Model No.	Capacity φ (mm)	Air Consumption (cm ³ /str.)	Applied Pressure (N)	Air Pressure (MPa)	A (mm)	B (mm)	Weight (g)	EDP No.
GT-HWR1	1.0	45	294	0.4~0.5	95	20	84	360701
GT-HWR10	1.8	116	588	0.4~0.5	146	36	295	360714

Double Action Air Scissors (Round Type without Lever)

GT-HWR1	1.0	0.5	45	294	0.4~0.5	95	20	84	360701
GT-HWR10	1.8	1.2	116	588	0.4~0.5	146	36	295	360714

Double Action Air Scissors (Square Type)

GT-HWS1	1.0	0.5	45	294	0.4~0.5	95	23x20	116	360700
GT-HWS10	1.8	1.2	116	588	0.4~0.5	146	36	356	360713

※Blades are optional.

No. GT-NZ15/20 Air Nipper for Orchid Support Stick NEW

- Equipped with a cutting position stopper for prevention of mistakes in cutoff.
- Blade is with a urethane cover to hold the stick that was cut, not to let cut pieces from being scattered.

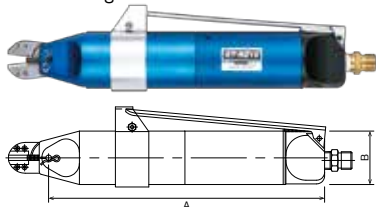

Model No.	Capacity	Air Consumption (cm ³ /str.)	Applied Pressure (N)	Air Pressure (MPa)	A (mm)	B (mm)	Weight (g)	EDP No.
GT-NZ15(NZ15AJ)	#10(Thin) φ4.2~6	250	1177	0.65	213.5	40	455	—
GT-NZ15(NZ20AJ)	#8(Thick) φ4.2~6	250	1177	0.65	213.5	40	465	360758

GT-HWR

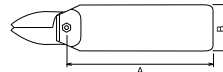

GT-HWS

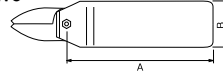

Applicable Blade Specifications

Model No.	Blade Opening (mm)	Cutting blade effective (mm)	A (mm)	Weight (g)	EDP No.
For GT-HWR1/HWS1					
HW1J	3.0	17	25	16	360452
For GT-HWS10					
HW10J	5.0	28	40	76	360462

For GT-HWR1/HWS1

HW1J	3.0	17	25	16	360452
------	-----	----	----	----	--------

For GT-HWS10

HW10J	5.0	28	40	76	360462
-------	-----	----	----	----	--------

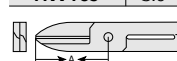

Note: The GT-NZ15/20 are designed for orchid support sticks available in Japan. This may not meet requirements in the overseas market. We don't have custom-made models for these nippers.



Applicable Blade Specifications

Model No.	Blade Opening (mm)	Cutting blade effective (mm)	A (mm)	Weight (g)	EDP No.
NZ15AJ	7.2	15	30	132	360504
NZ20AJ	7.5	15	31	142	360505

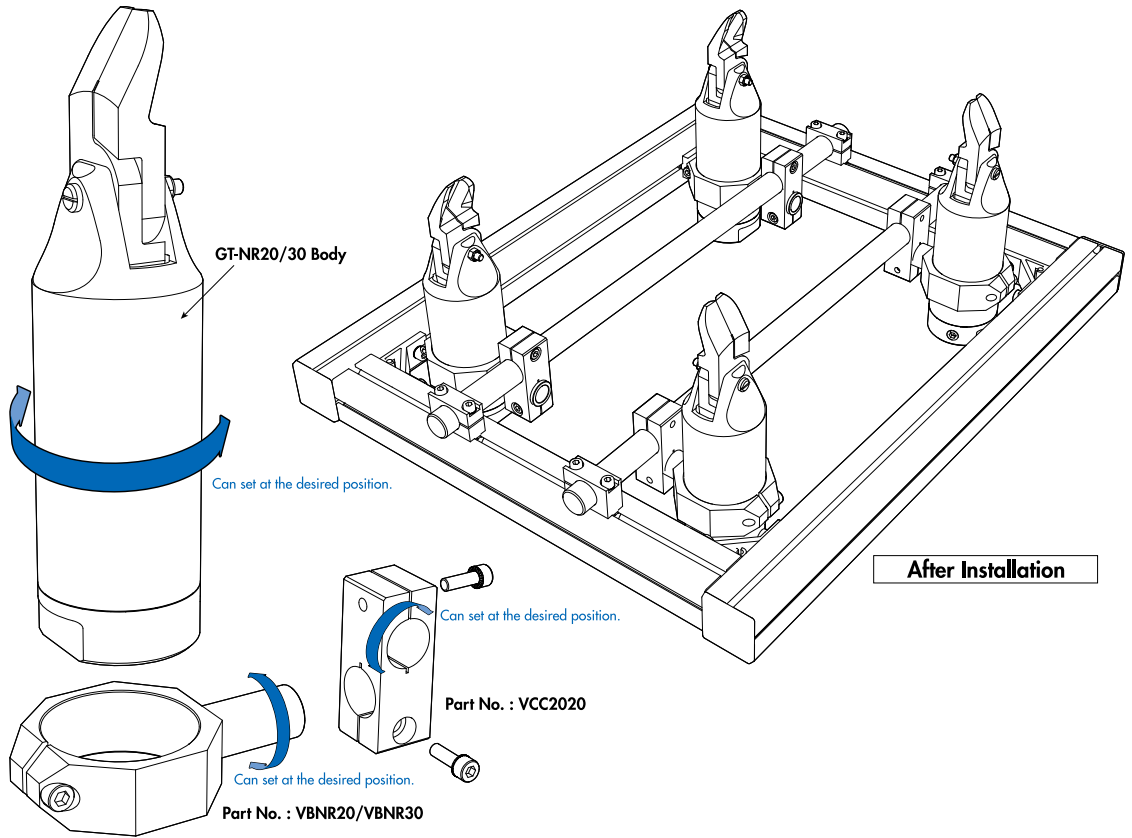

No. VCC200 Cross Connector

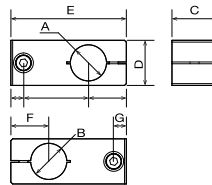

Model No.	Size (mm)							Weight (g)	EDP No.
	A	B	C	D	E	F	G		
VCC200	Φ20	Φ20	25	25	64	21	65	68	360050

No. VBNR20/VBNR30 Bracket for the GT-NR20/30

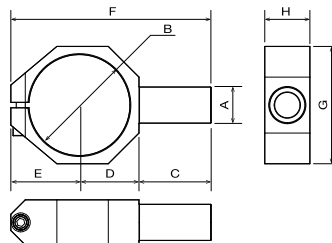

Model No.	Size (mm)								Weight (g)	EDP No.
	A	B	C	D	E	F	G	H		
VBNR20	Φ20	Φ45	35	28	31.5	94.5	53	20	65	360060
VBNR30	Φ20	Φ56	40	33	38	111	65	25	110	360061

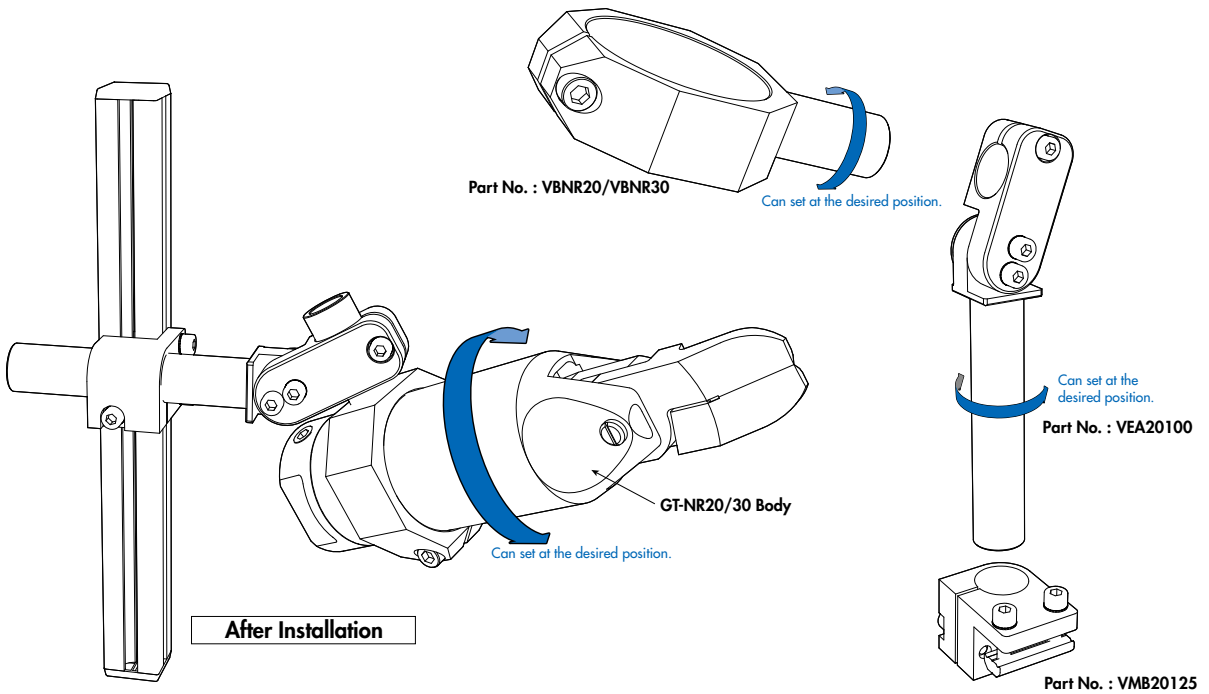

No. VEA20100 Elbow Arm

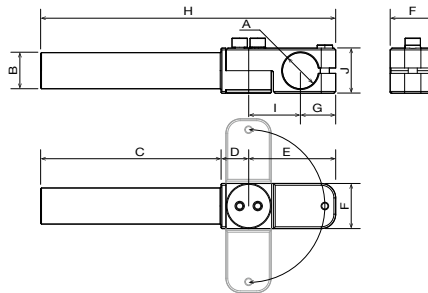

Model No.	Size (mm)										Weight (g)	EDP No.
	A	B	C	D	E	F	G	H	I	J		
VEA2010	Φ20	Φ20	100	15.3	48.2	25	19.5	163.5	28.7	25	115	360062

No. VMB20125 Mounting Bracket

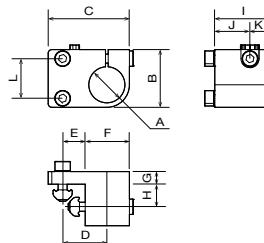

Model No.	Size (mm)												Weight (g)	EDP No.
	A	B	C	D	E	F	G	H	I	J	K	L		
VMB20125	Φ20	32	45	24.5	12.5	24.5	7	12.5	30	19.5	10.5	22	70	360049

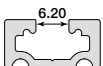

T-NUT of our product is for profile of below type.
Please obtain proper T-NUT from profile supplier
when our T-Nut does not fit your profile.

We design your custom-made blades, even from 1 piece!

VESSEL provides solutions of customized blades for a wide variety of applications.

Custom-made blades are designed flexibly according to a wide range of demands and offered at the minimum cost and lead-time.

See the examples below. We accept orders for small quantity as well.

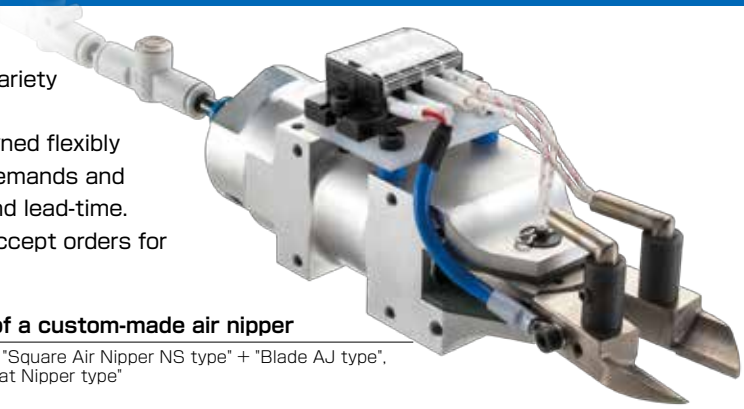

An example of a custom-made air nipper

A combination of "Square Air Nipper NS type" + "Blade AJ type", modified to a "Heat Nipper type"

Ref: What the model code stands for

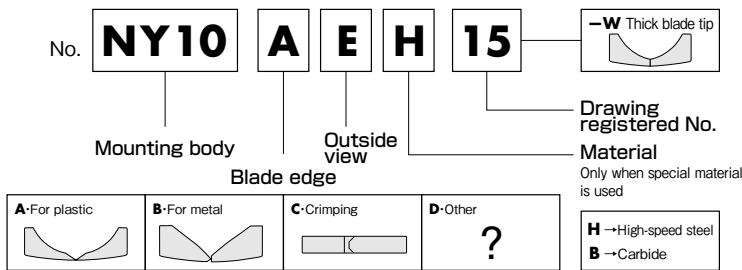

Type for blades

A Angled	B Angled	C Crimping	
D Mounted gate	E Disposable gate treatment	F Power cutting	G Punching
I Pilers type	J(JL) Long blade for plastic Straight Long blade For product which are vertically long and to which a nipper does not reach with an ordinary blade.	K L-shaped (disposable gate treatment)	L L-shaped
M/XL/XR Side opening blades	TN Tube cutting	VO Nail pulling	DI Bending
VHA Scissors	AHE Pin gate treatment ...Treatment of small gates which should be automatically cut at de-gating.	AHW Double blades	NH Double heating blades
H Crankshaft			Cutting of stranded wire Film gate