



Instruction Manual

CCD Laser Displacement Sensor

LK Series

CONTENTS

Safety Precautions	2
Laser safety precautions	3
Part Names	7
Connections	8
Input/Output Circuit	9
Installation	9
Power-on	10
Output Characteristics and LED indicator [LK-031/081/501/503 in Long range mode]	10
Output Characteristics and LED indicator [LK-501/503 in high-precision mode]	11
Setting	12
Functions	
AUTO ZERO	13
SHIFT/SPAN	14
SENSITIVITY SETTING	15
DIP SWITCHES	16
DIP SWITCHES	17
MEASUREMENT MODE SELECTION [with LK-501/503 only]	18
Hints on Correct Use	19
Input Characteristics	20
Specifications	21
Characteristics	22
Mutual Interference	23
Dimensions	23
WARRANTIES AND DISCLAIMERS	27



This is a class A (EN55011: EMI standard) product. In a domestic environment this product may cause radio interference in which case the user may be required to take adequate measures.



Class 3B laser product

Do not directly look at or touch the laser beam or the laser beam reflected from a mirror-surfaced object. This may cause serious eye or skin injury.

SAFETY PRECAUTIONS

This manual describes how to install the LK series as well as its operating procedures and precautions. Please read this manual carefully to get the best from your LK series.

Safety precautions

Symbols

The following symbols alert you to important messages. Be sure to read these messages carefully.



Failure to follow instructions may lead to injury. (electric shock, burn, etc.)



Failure to follow instructions may lead to product damage.

Note

Provides additional information on proper operation.

General precautions

- At startup and during operation, be sure to monitor the functions and performance of the LK series.
- We recommend that you take substantial safety measures to avoid any damage in the event a problem occurs.
- Do not open or modify the LK series or use it in any way other than described in the specifications.
- When the LK series is used in combination with other instruments, functions and performance may be degraded, depending on operating conditions and the surrounding environment.
- Do not use the LK series for the purpose of protecting the human body.

LASER SAFETY PRECAUTIONS

1. Classification

Model	LK-031	LK-081	LK-501	LK-503
FDA	Class II	Class II	Class IIIb	Class II
IEC 825-1 11.1993	Class 2	Class 2	Class 3B	Class 2
DIN EN 60825-1 07.1994	Klasse 2	Klasse 2	Klasse 3B	Klasse 2

2. Warning labels

- 1) Warning labels
- 2) Aperture label
- 3) Protective housing label

FDA Class II [LK-031/081]

CAUTION	AVOID EXPOSURE
<p>LASER RADIATION- DO NOT STARE INTO BEAM</p>  <p>SEMICONDUCTOR LASER 670nm MAXIMUM OUTPUT 0.95mW PULSED RADIATION CLASS II LASER PRODUCT</p>	<p>LASER RADIATION IS EMITTED FROM THIS APERTURE.</p>

FDA Class II [LK-503]

CAUTION	CAUTION
<p>LASER RADIATION- DO NOT STARE INTO BEAM</p>  <p>SEMICONDUCTOR LASER 690nm MAXIMUM OUTPUT 0.95mW PULSED RADIATION CLASS II LASER PRODUCT</p>	<p>LASER RADIATION WHEN OPEN. DO NOT STARE INTO BEAM.</p> <p>AVOID EXPOSURE LASER RADIATION IS EMITTED FROM THIS APERTURE.</p>

FDA Class IIIb [LK-501]

DANGER	DANGER
<p>LASER RADIATION- AVOID DIRECT EXPOSURE TO BEAM</p>  <p>SEMICONDUCTOR LASER 690nm MAXIMUM OUTPUT 15mW PULSED RADIATION CLASS IIIb LASER PRODUCT</p>	<p>LASER RADIATION WHEN OPEN. AVOID DIRECT EXPOSURE TO BEAM.</p> <p>AVOID EXPOSURE LASER RADIATION IS EMITTED FROM THIS APERTURE.</p>

IEC Class 2 [LK-031/081]

	<p>LASER RADIATION DO NOT STARE INTO BEAM</p> <p>Maximum output 0.95mW Emitted wavelength 670nm Pulsed radiation</p> <p>CLASS 2 LASER PRODUCT in conformity to IEC825-1 11.1993</p>
CAUTION Laser radiation when open. Do not stare into beam.	

IEC Class 2 [LK-503]

	<p>LASER RADIATION DO NOT STARE INTO BEAM</p> <p>Maximum output 0.95mW Emitted wavelength 690nm Pulsed radiation</p> <p>CLASS 2 LASER PRODUCT in conformity to IEC825-1 11.1993</p>
CAUTION Laser radiation when open. Do not stare into beam.	

IEC Class 3B [LK-501]

<p>LASER RADIATION AVOID EXPOSURE TO BEAM</p> <p>Maximum output 15mW Emitted wavelength 690nm Pulsed radiation</p> <p>CLASS 3B LASER PRODUCT in conformity to IEC825-1 11.1993</p>	
CAUTION Laser radiation when open. Avoid exposure to beam.	AVOID EXPOSURE Laser radiation is emitted from this aperture.

IEC (French) Class 2 [LK-031/081]

	<p>RAYONNEMENT LASER NE PAS REGARDER DANS LE FAISCEAU</p> <p>Puissance maximale 0.95 mW Longueur d'onde émise 670nm Radiation pulsée</p> <p>APPAREIL À LASER DE CLASSE 2 conforme à CEI 825-1 11. 1993</p>
ATTENTION Rayonnement laser en cas d'ouverture. Ne pas regarder dans le faisceau.	

IEC (French) Class 2 [LK-503]

	<p>RAYONNEMENT LASER NE PAS REGARDER DANS LE FAISCEAU</p> <p>Puissance maximale 0.95mW Longueur d'onde émise 690nm Radiation pulsée</p> <p>APPAREIL À LASER DE CLASSE 2 conforme à CEI 825-1 11.1993</p>
ATTENTION Rayonnement laser en cas d'ouverture. Ne pas regarder dans le faisceau.	

IEC (French) Class 3B [LK-501]

<p>RAYONNEMENT LASER EXPOSITION AU FAISCEAU DANGEREUSE</p> <p>Puissance maximale 15mW Longueur d'onde émise 690nm Radiation pulsée</p> <p>APPAREIL À LASER DE CLASSE 3B conforme à CEI 825-1 11.1993</p>	
ATTENTION Rayonnement laser en cas d'ouverture. Exposition dangereuse au faisceau.	EXPOSITION DANGEREUSE Un rayonnement laser est émis par cette ouverture.

LASER SAFETY PRECAUTIONS

DIN Klasse 2 [LK-031/081]



DIN Klasse 2 [LK-503]



DIN Klasse 3B [LK-501]



3. Labels location

FDA Warning labels are attached to the sensor head as shown below. The IEC/DIN Warning labels are packaged with the LK series. Affix the Warning labels on the sensor head as shown below.

LK-031/081/503

FDA

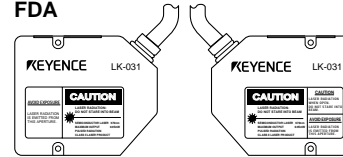

IEC

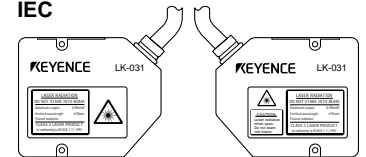

IEC (French)

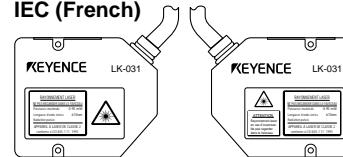

DIN

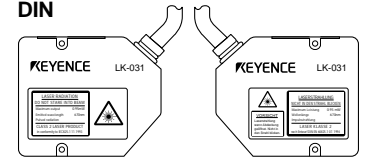

LK-501

FDA

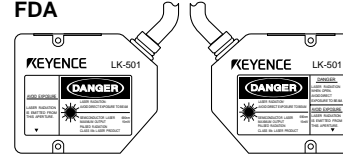

IEC

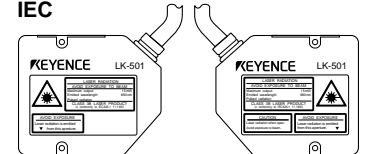

IEC (French)

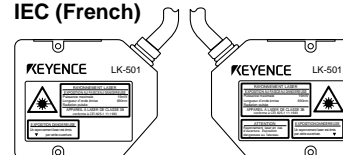

DIN

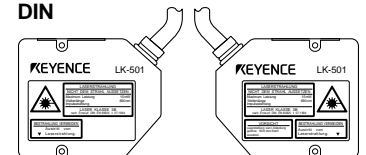

LASER SAFETY PRECAUTIONS

4. Safety consideration

1) Class IIIb laser products

CAUTION

Use of controls or adjustments, or the performance of procedures other than those specified herein, may result in hazardous radiation exposure.

WARNING

Follow the safety precautions below to ensure operator safety:

- **Do not directly look at or touch the laser beam or the laser beam reflected from a mirror surfaced object. This may cause serious eye or skin injury.**
- **Operate the LK series only according to the procedures described in this instruction manual.**
Otherwise, injury may occur due to exposure to the laser beam.
- **Do not disassemble the sensor head.**
Laser emission from the LK series is not automatically stopped if the sensor head is disassembled. If you disassemble the sensor head for inspection or repair, you may be exposed to the laser beam. If the LK series malfunctions, contact KEYENCE immediately.
- **Protective enclosure**
We recommend that you install a protective enclosure around the sensor head to prevent any person from getting near the sensor head during operation.
- **Protective goggles**
We recommend that you wear protective goggles when using the LK series.
- **Stop laser emissions before cleaning the laser emission port.**
Failure to stop the laser emission may expose eyes or skin to the laser beam.
- **Check the laser beam path.**
To prevent exposure to the laser beam due to specular or diffuse reflection, install a screen which offers the appropriate reflectance and temperature characteristics to interrupt the reflected laser beam. Do not install the LK series in such a way that the laser beam passes at eye height.

2) Class II laser products

CAUTION

Use of controls or adjustments, or the performance of procedures other than those specified herein, may result in hazardous radiation exposure.

The laser beam is not harmful to the skin. There is, therefore, no danger in exposing arms or hands to the beam. The only possible health hazard is in exposing the eyes to the laser beam. Damage to the eyes can occur if the operator stares directly into the beam.

WARNING

Follow the safety precautions below to ensure operator safety:

- **Operate the LK series only according to the procedures described in this instruction manual.**
Otherwise, injury may occur due to exposure to the laser beam.
- **Do not disassemble the sensor head.**
Laser emission from the LK series is not automatically stopped if the sensor head is disassembled. If you disassemble the sensor head for inspection or repair, you may be exposed to the laser beam. If the LK series malfunctions, contact KEYENCE immediately.
- **Do not look directly at the laser beam.**
Looking directly at the laser beam may result in serious eye injury.
- **Protective enclosure**
We recommend that you install a protective enclosure around the sensor head to prevent any person from getting near the sensor head during operation.
- **Protective goggles**
We recommend that you wear protective goggles when using the LK series.
- **Stop laser emissions before cleaning the laser emission port.**
Failure to stop the laser emission may expose eyes to the laser beam.
- **Check the laser beam path.**
To prevent exposure to the laser beam due to specular or diffuse reflection, install a screen which offers the appropriate reflectance and temperature characteristics to interrupt the reflected laser beam. Do not install the LK series in such a way that the laser beam passes at eye height.

LASER SAFETY PRECAUTIONS

5. Safety features provided with the LK series

The LK series is provided with the following safety features. Make sure these features function correctly before operating.

■ Key-operated laser switch

A key-operated switch controls the LK series laser. Remove the key when the laser is not in use.

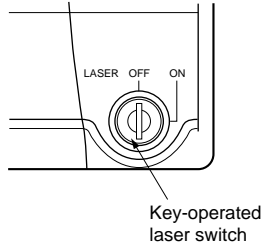

■ Laser ON alarm LED (Is ON during laser emission.)

After the key-operated laser switch is set to the ON position, the laser ON alarm LED flashes for approximately 3 seconds before laser emission. The LED lights during laser emission. The LED light can be checked through protective goggles.

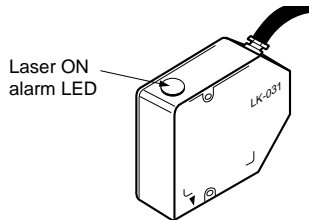

■ Remote interlock terminal

Laser emission can be stopped by disconnecting the REMOTE terminal from the GND terminal.

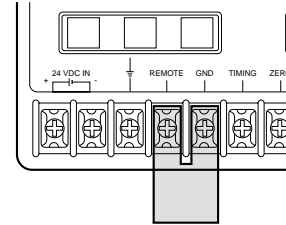

■ Laser beam shield (shutter) [with LK-501/503 only]

Laser emission is blocked by attaching the shutter.

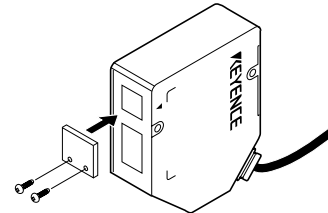

PART NAMES

Controller

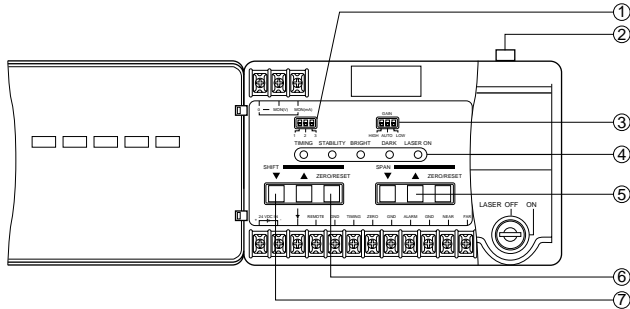

Sensor head

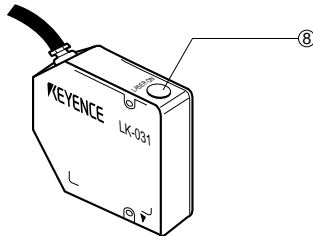

- ① **DIP switches**
Set alarm hold function, key-lock function, and averaging function.
- ② **Sensor head connector**
- ③ **Sensitivity setting switch**
Changes the received light sensitivity according to the reflectance of the target. (⇒ Refer to p. 15)
- ④ **Indicators**
TIMING: Lights during synchronous (timing) input.
STABILITY: Lights yellow or green when a target is within the measuring range. Lights red when a target is out of the measuring range, or when the light quantity is insufficient or excessive.
BRIGHT: Lights when the light quantity is excessive.
DARK: Lights when the light quantity is insufficient.
LASER ON: Lights during laser emission.
- ⑤ **SPAN adjustment keys**
Finely adjusts the inclination of the analog output.
- ⑥ **AUTO ZERO/RESET keys**
Resets the analog output to 0 V (12 mA) at any point. Cancels AUTO ZERO function.
- ⑦ **SHIFT adjustment key**
Finely adjusts the 0-point position of the analog output.
- ⑧ **Operation indicator**
Lights yellow or green when a target is within the measuring range. Flashes yellow when a target is out of the measuring range, or when the light quantity is insufficient or excessive.

CONNECTIONS

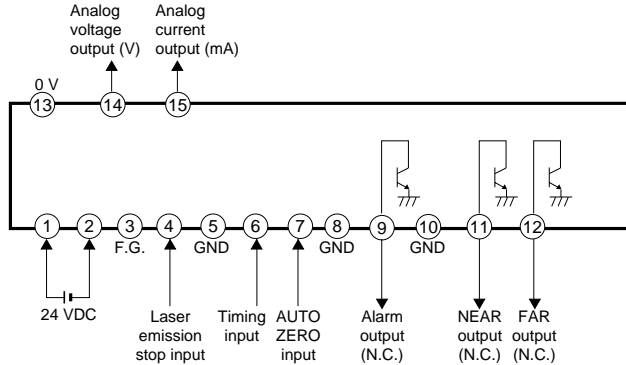

①, ② Power supply input terminal

③ Frame grounding (F.G.) terminal

Earth-ground this terminal.

④ Laser emission stop input

Disconnecting this terminal from the GND terminal (⑤, ⑧, ⑩) stops laser emission. Use this terminal in an emergency to stop laser emission.

⑥ Synchronous (timing) input

Connecting this terminal to the GND terminal (⑤, ⑧, ⑩) retains the analog output value just prior to the synchronous input, and stops laser emission.

⑦ AUTO ZERO input

Connecting this terminal to the GND terminal (⑤, ⑧, ⑩) resets the analog output to 0 V (12 mA). The input is a one-shot input.

⑨ Alarm output (N.C.)

The output contact opens when measurement is impossible due to an insufficient or excessive light quantity, or due to the target being out of the measuring range. The output is normally closed.

⑪ NEAR alarm output (N.C.)

The output contact opens when a target is positioned closer than the measuring range. The output is normally closed.

⑫ FAR alarm output (N.C.)

The output contact opens when a target is positioned further than the measuring range. The output is normally closed.

⑬, ⑭ Analog voltage output

A voltage of ± 5 V (± 10 V in LK-501/503's high-precision mode) relative to the full measurement range is output. +12 V is output when measuring is impossible.

⑮, ⑯ Analog current output

A current of 4 to 20 mA relative to the full measuring range is output. 31.2 mA is output when measuring is impossible.

Note: The analog current remains at 0 mA over the measurement range with an analog voltage output of -7.5 V or less.

INPUT/OUTPUT CIRCUIT

Input circuit (AUTO ZERO, synchronous, and laser emission stop)

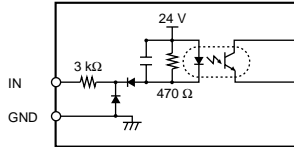

Output circuit (Alarm, NEAR, and FAR)

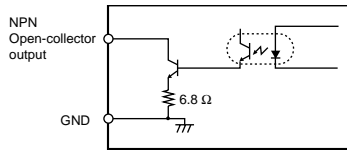

Note: Use a non-voltage contact to connect or disconnect the input terminals.

INSTALLATION

Controller

The controller can be mounted to a DIN rail. When mounting or removing the controller, pull the claw at the bottom center in the direction of the arrow.

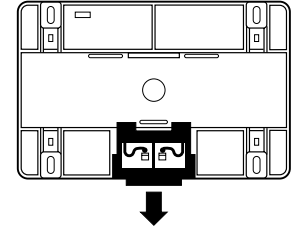

Connecting sensor head and controller

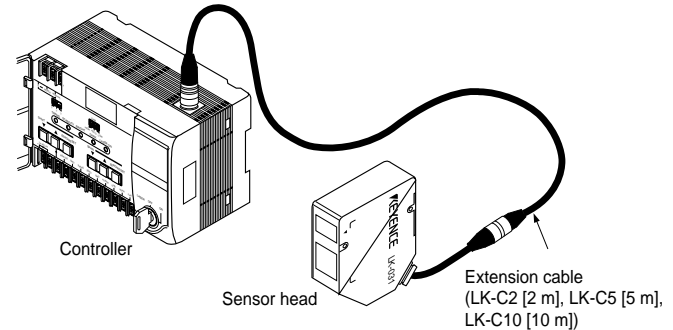

Connect the sensor head to the extension cable(s), and the extension cable(s) to the controller as shown above.

To join the connectors, gently press them together and turn them to the right or left to locate the engagement position, then press until a click is heard.

To remove the connectors, hold the connecting sleeve as shown on the right, and pull it out in the direction of the arrow.

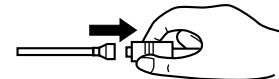

INSTALLATION

Sensor head

Secure the LK-031 and LK-081 with M4 screws, or the LK-501/503 with M5 screws using the two mounting holes indicated by the arrows.

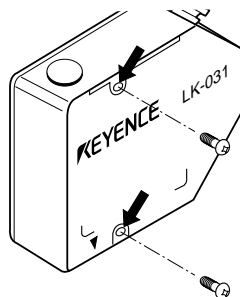

POWER-ON

1. Provide a 24 VDC power supply to terminals No. 1 and 2.
2. Set the key-operated switch to the ON position. The laser beam is emitted from the sensor head and the unit is ready to perform measurement. (Connect the REMOTE and GND terminals with a shorting jumper.)

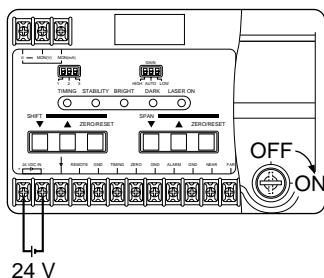

OUTPUT CHARACTERISTICS AND LED INDICATOR [LK-031/081/501/503 IN LONG RANGE MODE]

Adjust the distance between the sensor head and target by checking the sensor head's LED operation indicator.

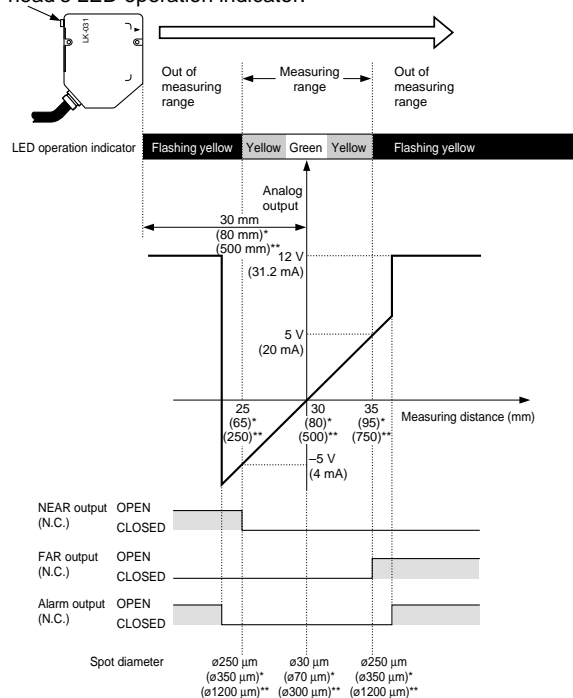

Data given in ()* applies to the LK-081.
Data given in ()** applies to the LK-501/503 in long-range mode.

Note 1: The NEAR or FAR output turns on only when the target moves slowly from the inside to the outside of the measuring range.

Note 2: When measurement is affected by the scattered reflection of a mirror-surfaced target, the operation indicator remains in the normal status, and the alarm output is not turned on even if the target is out of the measuring range.

OUTPUT CHARACTERISTICS AND LED INDICATOR

[LK-501/503 IN HIGH-PRECISION MODE]

Adjust the distance between the sensor head and target by checking the sensor head's LED operation indicator.

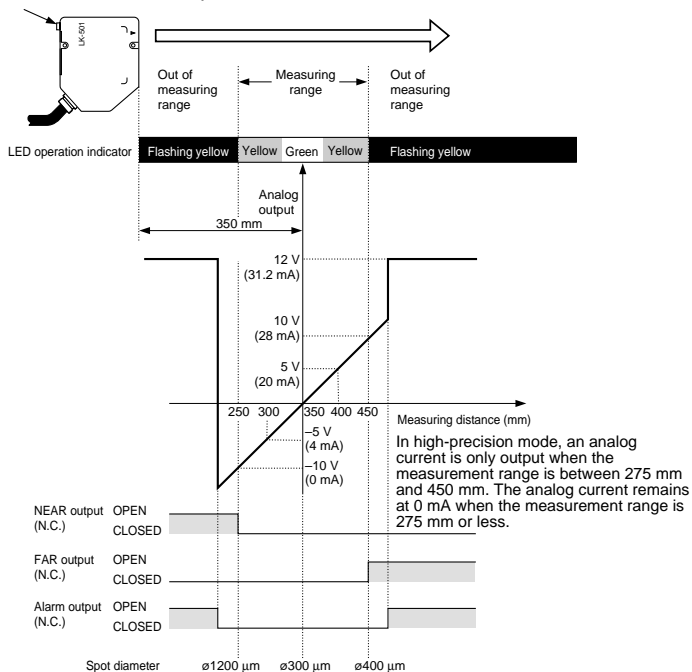

Note 1: The NEAR or FAR output turns on only when the target moves slowly from the inside to the outside of the measurement range.

Note 2: When measurement is affected by scattered reflections from a mirror-surfaced target, the operation indicator shows normal status, and the alarm output is not turned on even if the target is out of the measurement range.

SETTING

Measuring distance

LK-031/081/501/503

To measure the thickness of a moving object, place the target close to the reference position where the spot diameter is smallest. This assures the most stable detection.

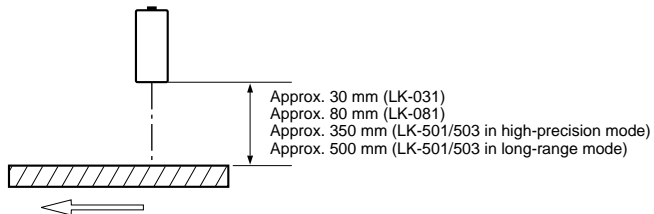

Border of different color or luster

Correct

Incorrect

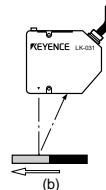
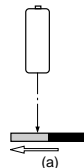

Displacement in a hole

Correct

Incorrect

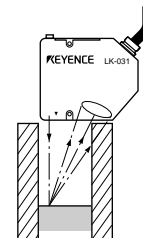
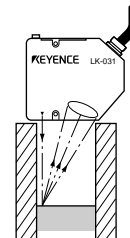

Target shape and recommended setting

The LK series is less affected by the sensor head orientation by employing the CCD as the light-receiving element. For the following applications, however, mount the sensor head with the recommended orientation, if possible.

Moving object

Correct

Incorrect

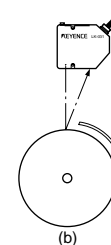
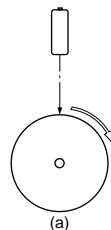

Height-difference

Correct

Incorrect

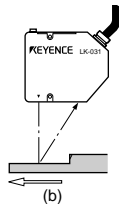
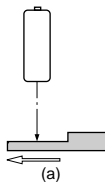

By a wall

Correct

Incorrect

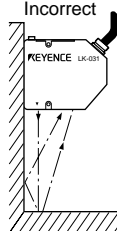
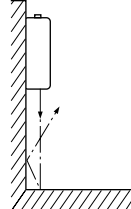

FUNCTIONS AUTO ZERO

AUTO ZERO function

Resets the output voltage to 0 V at the desired point within the measuring range.

Changing the zero position enables the output range to be set at either -10 to 0 V, or 0 to 10 V.

Example

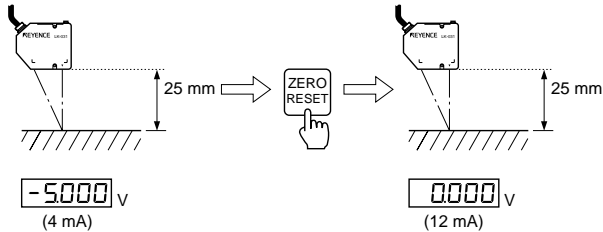

Canceling AUTO ZERO:

Press the ZERO RESET key for approximately 2 seconds. AUTO ZERO is canceled and 0 V (12 mA) is output when the target is at the reference position.

External input:

Connecting the AUTO ZERO input terminal to the GND terminal sets the AUTO ZERO input.

Relationship between the key-lock function and AUTO ZERO function

⇒ Refer to p. 16 for the key-lock function.

When FREE is set:

The value of the AUTO ZERO input is internally stored and retained even the power is turned off.

When LOCK is set:

The AUTO ZERO input is available only from the external input terminal. When the power is turned off, the value of the AUTO ZERO input is not stored, and the zero point is reset to the reference position.

Note: If the AUTO ZERO input is used frequently, set the key-lock function to LOCK, and set the AUTO ZERO externally.

AUTO ZERO position and output characteristics

LK-031/081

LK-501/503 (Long-range mode)

LK-501/503

(High-precision mode)

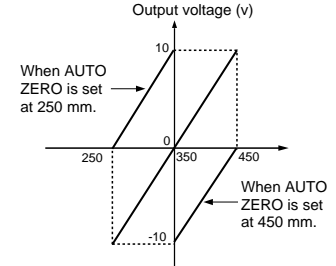
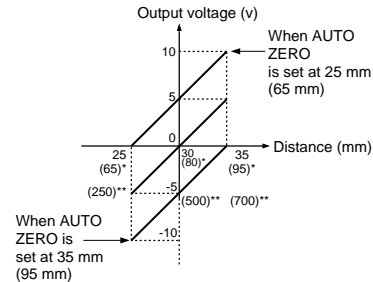

Data in () * applies to the LK-081.

Data in () ** applies to the LK-501/503 in long-range mode.

Note: When the AUTO ZERO input is set immediately after the power is turned on, there may be a 10 mV error due to the temperature characteristics of the internal circuit. The error is gradually reduced and becomes 0 V in approximately 30 minutes.

The temperature characteristics may cause low accuracy of the AUTO ZERO reset depending on the ambient temperature.

FUNCTIONS SHIFT/SPAN

Shift adjustment function

Adjusts the analog value zero point using the UP/DOWN keys for shift adjustment.

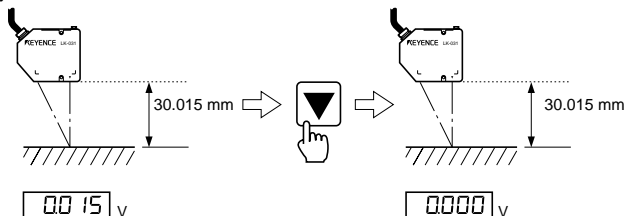

Holding down the UP/DOWN keys to change the shift value faster. Pressing the ZERO RESET key for 2 seconds cancels the shift adjustment value, and 0 V (12 mA) is output when the target is at the reference position.

■ Shift adjustment range

LK-031/081
LK-501/503 (Long-range mode)

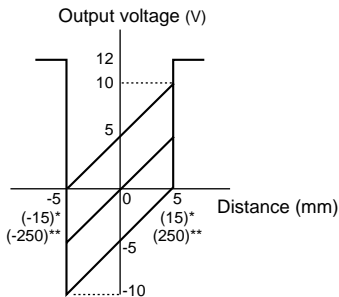

Data in () * applies to the LK-081.
Data in () ** applies to the LK-501/503 in long-range mode.

LK-501/503
(High-precision mode)

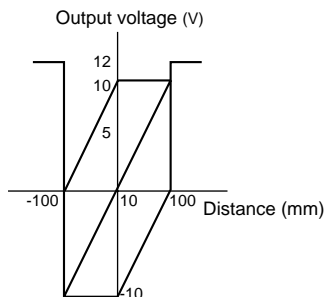

Span adjustment function

Adjusts the analog value inclination using the UP/DOWN keys for span adjustment. Use the span adjustment when the sensor head is tilted or the target surface condition affects the analog output characteristics.

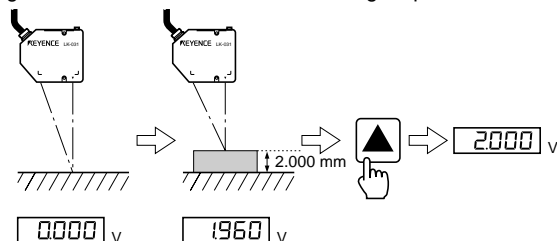

Value is inaccurate due to reflective property of the target surface.

Holding down the UP/DOWN keys to change the span value faster. Pressing the RESET key for 2 seconds cancels the span adjustment value, and the output characteristics are reset to the factory-set values.

■ Span adjustment range

LK-031/081
LK-501/503 (Long-range mode)

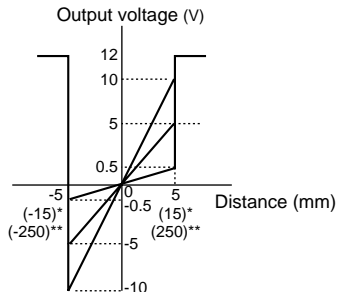

LK-501/503
(High-precision mode)

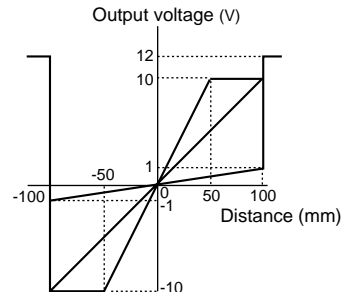

Data in () * applies to the LK-081.
Data in () ** applies to the LK-501/503 in long-range mode.

FUNCTIONS SENSITIVITY SETTING

Sets an appropriate sensitivity according to the change in target surface condition.

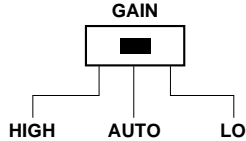

Set the sensitivity to AUTO for normal use.

AUTO:

Used to measure various objects: from objects with low reflectance such as black rubber, to ones with high reflectance such as metals.

Note: If the reflectance of the target changes greatly during a short cycle, the analog output may become unstable with the AUTO setting. In this case, set the sensitivity to HIGH or LO.

HIGH:

Fix the sensitivity to high. Used to measure a part with low reflectance (black) in the above condition.

LOW:

Fix the sensitivity to low. Used to measure a part with high reflectance in the above condition.

Example: Measurement of pin warpage

In the measurement of the warpage of moving pins, the reflectance of the pin and gap change greatly during a short cycle. To measure such a target, set the sensitivity setting switch to LO and measure only pins which have high reflectance.

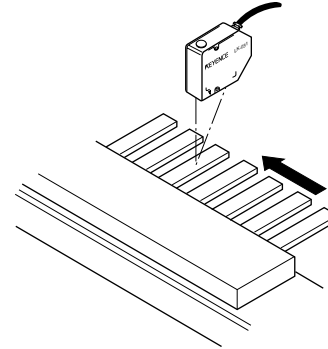

Output waveform obtained with AUTO

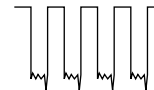

Output waveform obtained with LO



FUNCTIONS DIP SWITCHES

Alarm hold function

DIP switch 1

When DIP switch 1 is set to the upper position, the sensor does not produce the 12 V (31.2 mA) analog output during alarm output (range over/light quantity alarm), but retains the analog output value just prior to alarm output. This function is canceled when measurement is again possible.

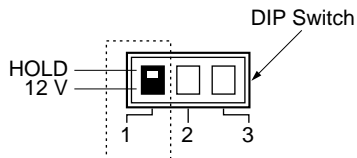

When the DIP switch 1 is set to the lower position, the sensor produces the 12 V (31.2 mA) analog output during alarm output.

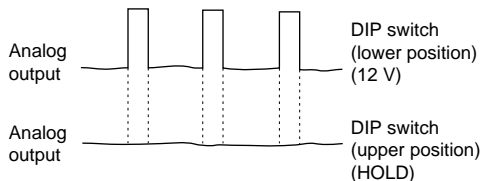
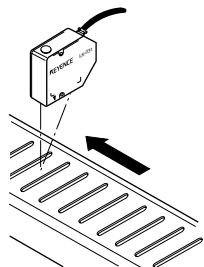

The condition in which the measurement is impossible can be ignored, eg. the detection of holes in a target.

Note: The alarm output is produced in the alarm condition even if the alarm hold function is used.

Key-lock function

DIP switch 2

When DIP switch 2 is set to the upper position, the sensor locks the shift adjustment, span adjustment, ZERO RESET and RESET keys so that each function cannot change. The shift (AUTO ZERO) and span values are fixed just prior to the lock operation.

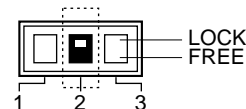

Use this function to prevent the output voltage from being accidentally reset to zero.

When the DIP switch 2 is set to the lower position, the key-lock function is set to FREE and the lock operation is canceled.

The AUTO ZERO input through the external input terminal is effective regardless of the LOCK or FREE setting. (However, with the LOCK set, the data will not be stored when the power is turned off.)

FUNCTIONS DIP SWITCHES

Response speed selection function

DIP switch 3

Set DIP switch 3 to select whether to output every measured value or the average of 8 measured values (moving average).

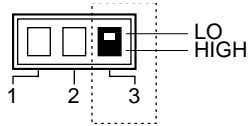

LO:

Outputs the value of the average of 8 measured values. Offers more stable detection when the luster of the target varies greatly.

HIGH:

Outputs every measured value. Offers high-speed response when the target vibrates or moves quickly.

Average response time	LO	HIGH
LK-031	Approx. 4 ms	Approx. 0.5 ms (no averaging)
LK-081/LK-501/503	Approx. 8 ms	Approx. 1.0 ms (no averaging)

Example: When LO is set

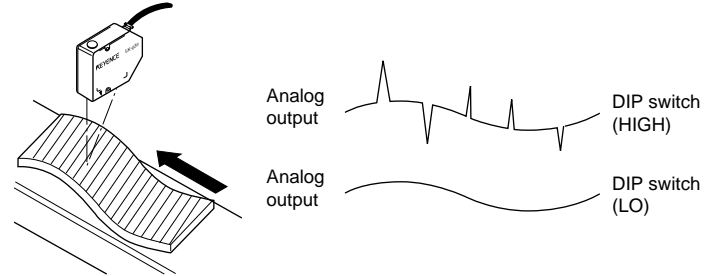

Example: When HIGH is set

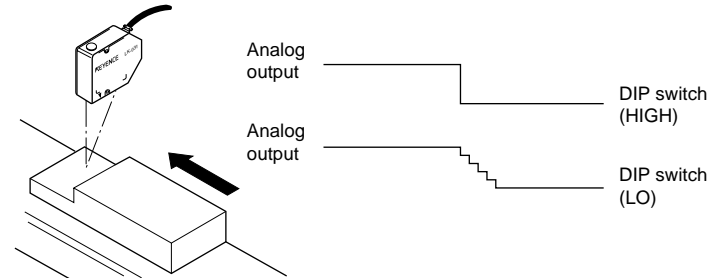

The HIGH setting is effective in detecting abrupt changes, such as height differences.

FUNCTIONS MEASUREMENT MODE SELECTION [WITH LK-501/503 ONLY]

The LK-501/503 offers two measurement modes to be used according to the measurement conditions.

Long-range mode

Measures within a range of 250 to 750 mm.

Use long-range mode to mount the sensor head at a distance from the target, or to obtain a long measurement range.

High-precision mode

Measures within a range of 250 to 450 mm.

Use high-precision mode to obtain high resolution.

■ Mode selection

Hold down the UP key for the SHIFT adjustment, and turn the key-operated laser switch from OFF to ON. This changes the measurement mode.

Note: The measurement mode is factory-set to long-range mode. The measurement mode is toggled every time the above operation is performed.

Long-range mode → High-precision mode → Long-range mode → High-precision mode....

■ Mode confirmation

Press the ZERO/RESET key for the SHIFT adjustment and the RESET key for the SPAN adjustment simultaneously. The indicators illuminate to show the current measurement mode.

When long-range mode is set:

Status of indicators



All five indicators illuminate.

When high-precision mode is set:

Status of indicators



Three indicators, BRIGHT, DARK, and LASER ON, illuminate.

HINTS ON CORRECT USE

■ Noise interference (The sensor head is case-grounded.)



Isolate the sensor cable and extension cable(s) from high-tension lines or power lines, otherwise the sensor may malfunction or the laser diode may deteriorate due to noise interference.

- If noise is present at the surface where the sensor head is mounted, install insulator between the mounting surface and the sensor head.
- Earth-ground the frame grounding terminal.



Do not connect the sensor head while the controller is turned on. The sensor head may be damaged.

■ Compatibility

The LK series controller and sensor head have been calibrated in pairs. Be sure to use a sensor head and controller having the same serial number, otherwise the values given in the specifications cannot be attained.

■ Environment



Keep the sensor head free of water or oil. Any substance that refracts light may cause unstable measurement.

Do not allow extraneous light to enter the lens of the sensor head directly.

- * When highly accurate measurement is required, attach shielding to the sensor head. If extraneous light enters the lens when no target is present, use a synchronous input to ignore it.

■ Ambient light

Although up to 10,000 lux ambient light is allowed by the specifications, avoid using the sensor near lighting equipment that emits light in recurring pulses, if possible. If the sensor must be positioned near such equipment, minimize the effect by using a light shielding plate.

■ Warm-up

Allow approximately 30 minutes after the power is turned on before using the LK series. The measurement value may gradually fluctuate because the circuit is not stable immediately after the power is turned on.

■ Cable extension

Keep the sensor head cable as short as possible to prevent noise interference. (Less than 35 m)
Extension cables: LK-C2 (2 m), LK-C5 (5 m), and LK-C10 (10 m)

■ Sensor head orientation

When a target consists of different colored portions or different materials separated by a border, measurement error may result depending on the orientation of the sensor head. To minimize measurement deviation, install the sensor head parallel to the border line, as shown below.

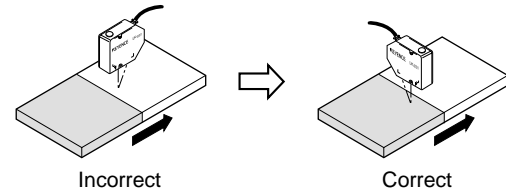

INPUT CHARACTERISTICS

Timing diagram

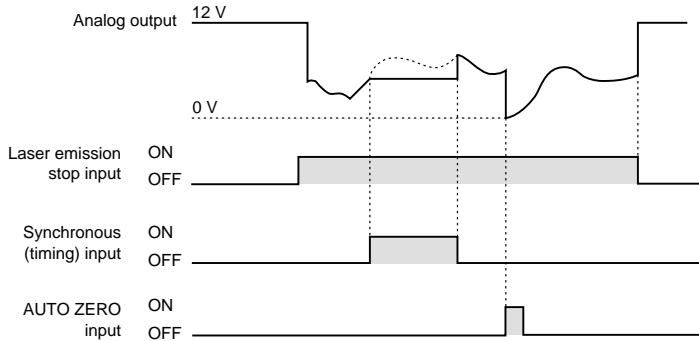

- Laser emission only starts approximately 2 seconds after the laser emission stop input terminal is connected.
- While the timing input is connected, laser emission stops. The analog output will hold the last value before the timing input signal turns on.

Minimum input time

Data in ()* applies to the LK-081.
Data in ()** applies to the LK-501/503.

Synchronous (timing) input

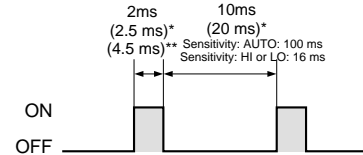

Note: The analog output is retained for the following amount of time after disconnection of the synchronous input terminal.

LK-031: Approx. 10 ms
LK-081: Approx. 20 ms
LK-501/503 (Sensitivity: AUTO): Approx. 100 ms
LK-501/503 (Sensitivity: HI or LO): Approx. 16 ms

AUTO ZERO input

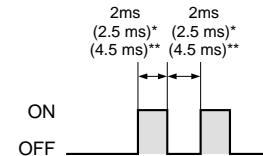

Note: The analog output is retained approximately 10 ms after the synchronous input terminal is disconnected.

SPECIFICATIONS

Model	Sensor head	LK-031	LK-081	LK-501/LK-503	
	Controller	LK-2001	LK-2101	LK-2501/LK-2503	
Measurement mode		—	—	Long-range	High-precision
Reference distance		30 mm	80 mm	500 mm	350 mm
Measuring range		±5 mm	±15 mm	±250 mm	±100 mm
Light source		Visible red semiconductor laser			
Maximum output		0.95 mW		LK-501: 15 mW, LK-503: 0.95 mW	
Pulse duration	FDA	3 to 482 μs	3 to 994 μs	3 to 994 μs	
	IEC	3 to 482 μs	3 to 994 μs	3 to 994 μs	
	DIN EN 60825-1 07.1994	3 to 482 μs	3 to 994 μs	3 to 994 μs	
Wavelength		670 nm		690 nm	
Class	FDA	Class II		Class IIIb (LK-501), Class II (LK-503)	
	IEC	Class 2		Class 3b (LK-501), Class 2 (LK-503)	
	DIN EN 60825-1 07.1994	Klasse 2		Klasse 3b (LK-501), Klasse 2 (LK-503)	
Spot diameter		Approx. 30 μm (at reference distance)	Approx. 70 μm (at reference distance)	Approx. 0.3 mm dia. (at reference distance)	Approx. 0.7 mm dia. (at reference distance)
Linearity		±0.1% of F.S. ¹			
Resolution		1 μm ²	3 μm ²	50 μm ²	10 μm ²
Analog output	Voltage	±5 V (1 mm/V)	±5 V (3 mm/V)	±5 V (50 μm/mV)	±10 V (10 μm/mV) ³
	Impedance	100 Ω			
	Current	4 to 20 mA (350 Ω max.) ^{3,4}			
Alarm output		NPN open-collector 100 mA (40 V) max. (N.C.) Residual voltage 1 V max. ³			
Sampling cycle		512 μs	1024 μs		
Other functions		AUTO ZERO, Alarm hold, GAIN selection, Response speed selection, Span/Shift adjustment			
Power supply		24 VDC ±10% Ripple (p-p): 10 % max.			
Current consumption		400 mA max.			
Temperature fluctuation	Sensor head	0.01% of F.S./°C		0.02% of F.S./°C	
	Controller	0.01% of F.S./°C			
Enclosure rating		IP-67			
Ambient light		Incandescent or fluorescent lamp: 10,000 lux max. ⁵			
Ambient temperature	Sensor head	0 to 50 °C (32 to 122 °F), No freezing			
	Controller	0 to 50 °C (32 to 122 °F), No freezing			
Relative humidity		35 to 85%, No condensation			
Vibration		10 to 55 Hz, 1.5 mm double amplitude in X, Y, and Z directions, 2 hours respectively			
Material	Sensor head	Aluminum die-cast			
	Controller	Polycarbonate			
Weight (including cable)	Sensor head	Approx. 260 g	Approx. 385 g	Approx. 700 g	
	Controller	Approx. 515 g			

1. Linearity was obtained using KEYENCE's standard target (white ceramic block gauge).

2. Resolution was obtained using KEYENCE's analog sensor controller (RD-50) with the number of averaging measurements set to 64.

Note: The ripple of the analog output may be 1 mV or more due to common mode noise when observed with an oscilloscope or high-speed A/D conversion board.

3. When measurement is impossible, 12 V (31.2 mA) is output.

4. The analog current output is 4 to 20 mA over the measurement range with an analog voltage output of ±5 V.

5. 5,000 lux max. with LK-503/2503.

CHARACTERISTICS

Angle characteristics

Changes the span of the analog output when a white ceramic target is tilted by $\pm 30^\circ$ (Typical)

LK-031

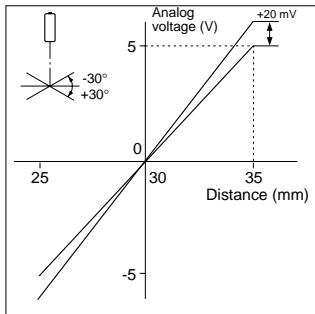
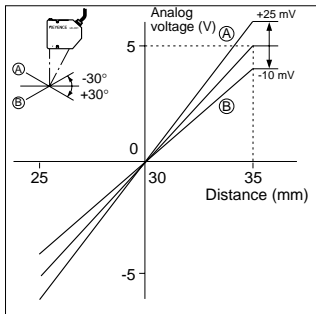

LK-501/503

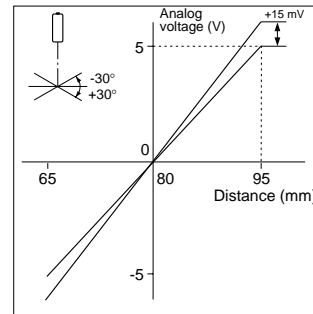
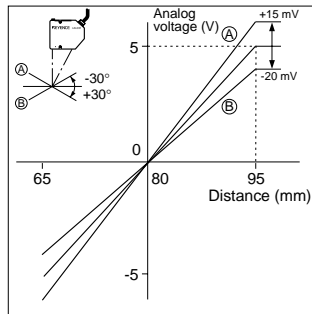

LK-081

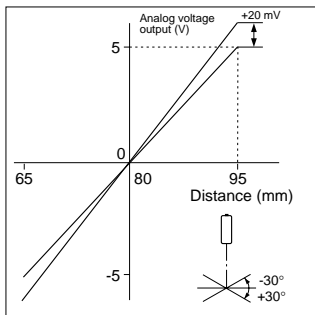
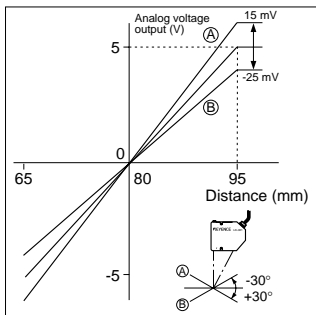

MUTUAL INTERFERENCE

Interference range

Interference will occur only when the beam spot of another sensor is positioned inside of the shadowed area.

LK-031

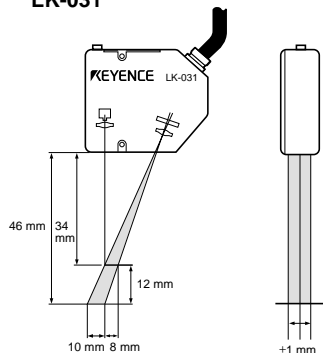

LK-081

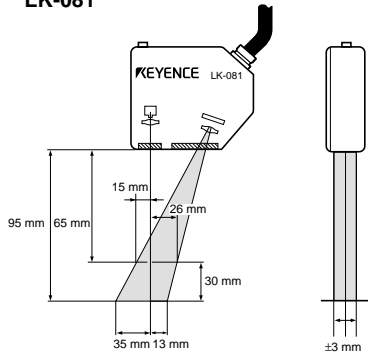

LK-501/503

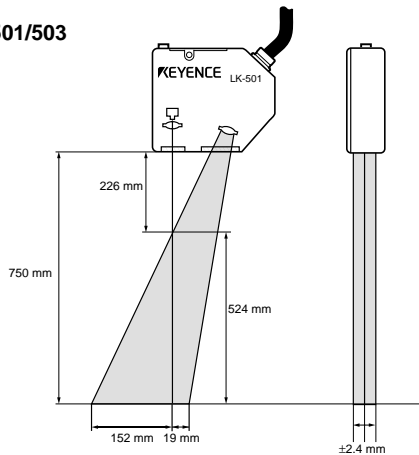

DIMENSIONS

Unit: mm

Sensor head

LK-031

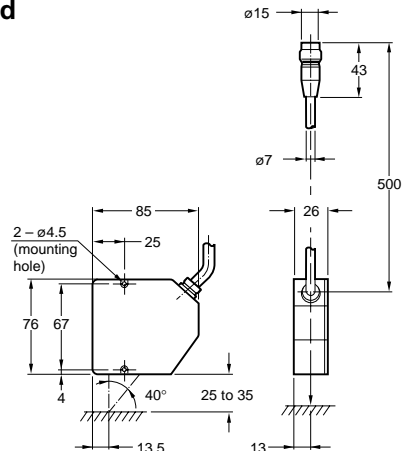

LK-081

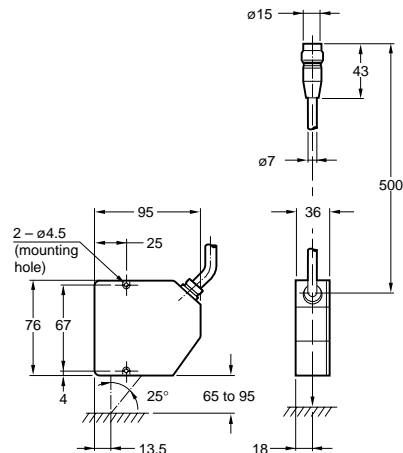

DIMENSIONS

Unit: mm

LK-501/503

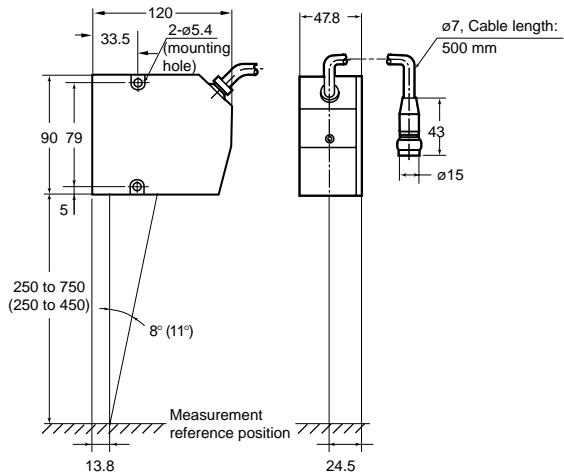

Controller

LK-2001/2101/2501/2503

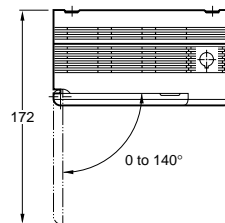

Extension cable

Cable length (m)	Model
2	LK-C2
5	LK-C5
10	LK-C10

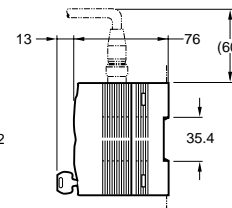
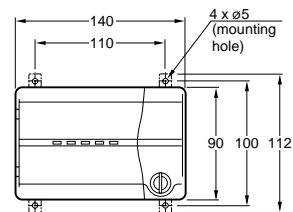

WARRANTIES AND DISCLAIMERS

(1) KEYENCE warrants the Products to be free of defects in materials and workmanship for a period of one (1) year from the date of shipment. If any models or samples were shown to Buyer, such models or samples were used merely to illustrate the general type and quality of the Products and not to represent that the Products would necessarily conform to said models or samples. Any Products found to be defective must be shipped to KEYENCE with all shipping costs paid by Buyer or offered to KEYENCE for inspection and examination. Upon examination by KEYENCE, KEYENCE, at its sole option, will refund the purchase price of, or repair or replace at no charge any Products found to be defective. This warranty does not apply to any defects resulting from any action of Buyer, including but not limited to improper installation, improper interfacing, improper repair, unauthorized modification, misapplication and mishandling, such as exposure to excessive current, heat, coldness, moisture, vibration or outdoors air. Components which wear are not warranted.

(2) KEYENCE is pleased to offer suggestions on the use of its various Products. They are only suggestions, and it is Buyer's responsibility to ascertain the fitness of the Products for Buyer's intended use. KEYENCE will not be responsible for any damages that may result from the use of the Products.

(3) The Products and any samples ("Products/Samples") supplied to Buyer are not to be used internally in humans, for human transportation, as safety devices or fail-safe systems, unless their written specifications state otherwise. Should any Products/Samples be used in such a manner or misused in any way, KEYENCE assumes no responsibility, and additionally Buyer will indemnify KEYENCE and hold KEYENCE harmless from any liability or damage whatsoever arising out of any misuse of the Products/Samples.

(4) OTHER THAN AS STATED HEREIN, THE PRODUCTS/SAMPLES ARE PROVIDED WITH NO OTHER WARRANTIES WHATSOEVER. ALL EXPRESS, IMPLIED, AND STATUTORY WARRANTIES, INCLUDING, WITHOUT LIMITATION, THE WARRANTIES OF MERCHANTABILITY, FITNESS FOR A PARTICULAR PURPOSE, AND NON-INFRINGEMENT OF PROPRIETARY RIGHTS, ARE EXPRESSLY DISCLAIMED. IN NO EVENT SHALL KEYENCE AND ITS AFFILIATED ENTITIES BE LIABLE TO ANY PERSON OR ENTITY FOR ANY DIRECT, INDIRECT, INCIDENTAL, PUNITIVE, SPECIAL OR CONSEQUENTIAL DAMAGES (INCLUDING, WITHOUT LIMITATION, ANY DAMAGES RESULTING FROM LOSS OF USE, BUSINESS INTERRUPTION, LOSS OF INFORMATION, LOSS OR INACCURACY OF DATA, LOSS OF PROFITS, LOSS OF SAVINGS, THE COST OF PROCUREMENT OF SUBSTITUTED GOODS, SERVICES OR TECHNOLOGIES, OR FOR ANY MATTER ARISING OUT OF OR IN CONNECTION WITH THE USE OR INABILITY TO USE THE PRODUCTS, EVEN IF KEYENCE OR ONE OF ITS AFFILIATED ENTITIES WAS ADVISED OF A POSSIBLE THIRD PARTY'S CLAIM FOR DAMAGES OR ANY OTHER CLAIM AGAINST BUYER. In some jurisdictions, some of the foregoing warranty disclaimers or damage limitations may not apply.

BUYER'S TRANSFER OBLIGATIONS: If the Products/Samples purchased by Buyer are to be resold or delivered to a third party, Buyer must provide such third party with a copy of this document, all specifications, manuals, catalogs, leaflets and written information provided to Buyer pertaining to the Products/Samples.