

VME64x System Subrack 2 U

User's Manual



Product No.:
20836-245

Rev.	Date updated	Change
R1.0	July 14, 2009	Initial Release

Impressum:

Schroff GmbH

D-75334 Straubenhardt, Germany

The details in this manual have been carefully compiled and checked - supported by certified Quality Management System to EN ISO 9001/2000

The company cannot accept any liability for errors or misprints. The company reserves the right to amendments of technical specifications due to further development and improvement of products.

Copyright © 2009

All rights and technical modifications reserved.

Table of Contents

1	Safety	1
1.1	Intended Application	1
1.2	Safety Instructions	2
1.2.1	Safety Symbols used in this document	2
1.3	General Safety Precautions	2
1.4	References and Architecture Specifications	3
2	Product Definition	4
2.1	Subrack System Overview	4
2.2	VME64x Backplane	5
2.3	Power Backplane	5
2.4	Power Supply	6
2.4.1	Grounding/Earthing	6
2.4.2	Plug-In AC Power Supply (Order separately)	7
2.4.3	Wiring Diagram	8
2.5	Cooling	9
3	Assembly	10
3.1	General Assembly Guidelines	10
3.1.1	Unpacking	10
3.1.2	Ensuring Proper Airflow	10
3.2	Rack-Mounting	11
4	Service	12
4.1	Technical support and Return for Service Assistance	12
4.2	Declaration of Conformity	12
4.3	Delivery comprises	13
4.4	Accessories	13
4.5	Replacement Parts	13
5	Technical Data	14
6	Dimensions	15

1 Safety

1.1 Intended Application

The VME64x system subrack, described in this manual, is intended as a platform for a microcomputer system based on the VME64x bus system (VITA 1.1-1997).

The VME64x system subracks are designed for protection class IP 20 and can be used only in the resp. environments.

For higher protection requirements, a.e. IP 54/55 you must install the system subrack in a protective case.

VME64x system subracks are not finished products, so there is no valid approval for these units. In order to enable stand-alone functionality, additional elements are required. An operational system is achieved only by way of appropriate VME64x boards.

The completion and final testing of the units have been carried out, or at least supervised, by qualified technicians. These instructions are directed exclusively to these qualified technicians i.e. engineers, trained and qualified electricians etc.



Make sure that:

- the assembled unit complies with the safety regulations currently applicable in the country it is going to be used.
- the overall unit complies with all other regulations and specifications at the place and country of use, e.g. interference limits, approval by the telecommunications authorities.

1.2 Safety Instructions

The intended audience of this User's Manual is system integrators and hardware/software engineers.

1.2.1 Safety Symbols used in this document

	<p>Hazardous voltage!</p> <p><i>This is the electrical hazard symbol. Familiarise yourself with the danger of electrical voltages and the safety precautions to avoid accidents before starting to work with parts that carry dangerous voltages.</i></p>
	<p>Caution!</p> <p><i>This is the user caution symbol. It indicates a condition where damage of the equipment or injury of the service personnel could occur. To reduce the risk of damage or injury, follow all steps or procedures as instructed.</i></p>
	<p>Danger of electrostatic discharge!</p> <p><i>Static electricity can damage sensitive components in a system. To avoid damage, wear ESD wrist straps or at regular intervals touch blank enclosure parts.</i></p>

1.3 General Safety Precautions

	<p>Warning!</p> <p><i>Voltages over 60 VDC can be present in this equipment. This equipment is intended to be accessed, to be installed and maintained by qualified and trained service personnel only.</i></p> <p><i>This equipment is designed in accordance with protection class 1!</i></p> <p><i>It must therefore be operated only with protective GND/earth connection!</i></p>
---	---

- Service personnel must know the necessary electrical safety, wiring and connection practices for installing this equipment.
- Install this equipment only in compliance with local and national electrical codes.

1.4 References and Architecture Specifications

- User Manual VME64x Backplanes
Order no.: 73972-103
- Short Form User Manual VME64x J1/J2 Monolithic Backplanes
Order no.: 73972-128
- Short Form User Manual Power Backplane 23098-115
Order no.: 73972-072
- Operating Instructions maxpowerPRO 250 W Power Supply 13100-141
Order no.: 73972-077
- Operating Instructions Fan Monitoring Module
Order no.: 63972-302

Further information can also be found in the catalogue „Electronic Packaging“ and on the internet under www.schroff.biz

2 Product Definition

The Schroff VME64x System Subrack consists of:

- A shielded 2 U 19" subrack with front and rear card cage for 4 VME64x 6 U boards in accordance with VME64x standard (VITA 1.1-1997) and two slots for optional 250 W plug-in power supplies
- A 4 slot 6 U VME64x (VITA 1.1-1997) backplane
- A power backplane with two P47 connectors
- Fan Tray with two fans and a fan monitoring module for the active cooling of the boards and the power supplies
- Power input module with IEC 320-C14 connector, mains/line switch, mains/line filter and fuses

2.1 Subrack System Overview

Figure 1: Subrack System Overview



10009833

- | | |
|---|--|
| 1 Front board cage with guide rails | 4 Power Supply (order separately) |
| 2 Fan Tray | 5 Slot for an additional power supply, covered with a 3 U / 8 HP front panel |
| 3 Power input module with IEC 320-C14 connector, mains/line switch, mains/line filter and fuses | 6 Rear board cage with guide rails |

The 2 U 19" steel chassis is black powder coated (RAL9005) and EMC shielded. The board cage enables the horizontal assembly of 4 VME64x front boards (6 U, 4 HP, 160 mm deep) and 4 Rear I/O Boards (6 U, 4 HP, 80 mm deep).

The right guide rails of the board cage are equipped with ESD clips.

2.2 VME64x Backplane

The horizontally assembled 6 U backplane (J1.J2 Monolithic) with P0 connectors conforms to:

VITA 1.1-1997

VITA 38 systems management for VME

At the right side is a connector for the power supply, at the left side a connector for the Fan Tray.



Further information can be found in the user manual of the backplane: Order-No. 73972-103, in the catalogue or on the internet at www.schroff.biz

2.3 Power Backplane

A Power Backplane (23098-115) is located to the right of the VME64x Backplane providing two P47 connectors to connect to 3 U / 250 W plug-in power supplies. The Power Backplane distributes the supply voltages to the VME64x Backplane.

For more information see the Backplane's User Manual, Order No.: 73972-072, in the catalogue and at www.schroff.biz

2.4 Power Supply

	<p>Hazardous voltage! <i>Parts of the power supply may be exposed with hazardous voltage. Always remove mains/line connector before carry out any assembly work.</i></p>
	<p>Caution! <i>Your system has not been provided with a AC power cable. Purchase a AC power cable that is approved for use in your country. The AC power cable must be rated for the product and for the voltage and current marked on the product's electrical ratings label. The voltage and current rating of the cable should be greater than the ratings marked on the product.</i></p>

The VME64x system can be powered by plug-in power supplies with wide range input (100 - 240 VAC), Schroff order-no. 13100-141.

The power supplies can be plugged-in in dedicated slots at the right front side. The power supplies contact via 47-position connectors to the power backplane.

The power input is provided by a AC mains/line module with IEC 320-C14 connector, integrated mains/line fuses and line filter.

The fuse rating is 8 A slow blow.

Figure 2: AC Terminal - Grounding

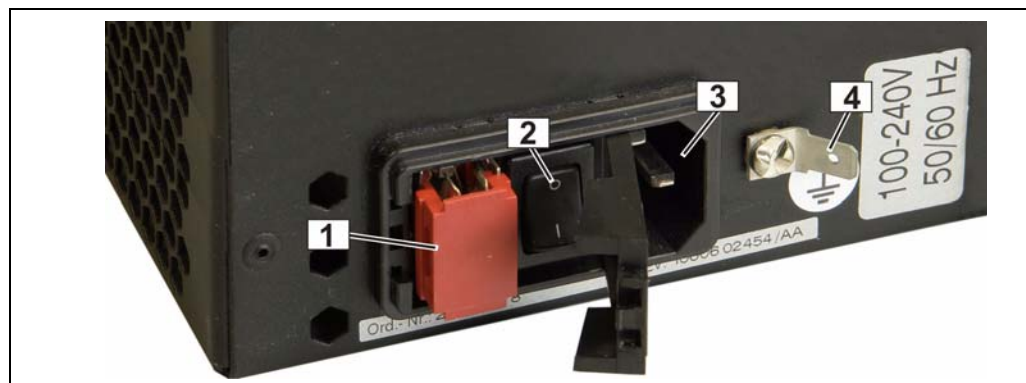

10009832

- | | | | |
|---|-------------------|---|---------------------------|
| 1 | Fuseholder | 3 | AC Connector (IEC320-C14) |
| 2 | Mains/line switch | 4 | 6,3 mm faston connector |

2.4.1 Grounding/Earthing

	<p>Caution! <i>The unit is designed in accordance with protection class 1! It must therefore be operated with protective earth/GND connection. Use only a three conductor AC power cable with a protective earth conductor that meets the IEC safety standards!</i></p>
---	--

There is a 6,3 mm faston connector at the rear panel. This connector is only for equipotential bonding. Grounding is achieved through the protective earth conductor of the power cable!

2.4.2 Plug-In AC Power Supply (Order separately)

Figure 3: Schroff Power Supply 13100-141



10006814

Table 1: Data AC Power Supply

Input voltage nominal	100 - 240 VAC
Mains Frequency	50 / 60 Hz
Output (max.)	250 W
Output voltages	3.3 V - 40 A 5.0 V - 40 A 12.0 V - 5.5 A -12.0 V - 2 A
Ripple	< 1 %
Dynamic response	< 1 % or 60 mV
Recovery time to within 1%	< 300 µsec
Overvoltage protection	for all voltages 120 – 130 % U > 5 Vr
Overcurrent protection	105 – 130 % of rated output current
Hold-up time	>= 20 ms



An 48 VDC power supply is available on request.

2.4.3 Wiring Diagram

Figure 4: Wiring Diagram

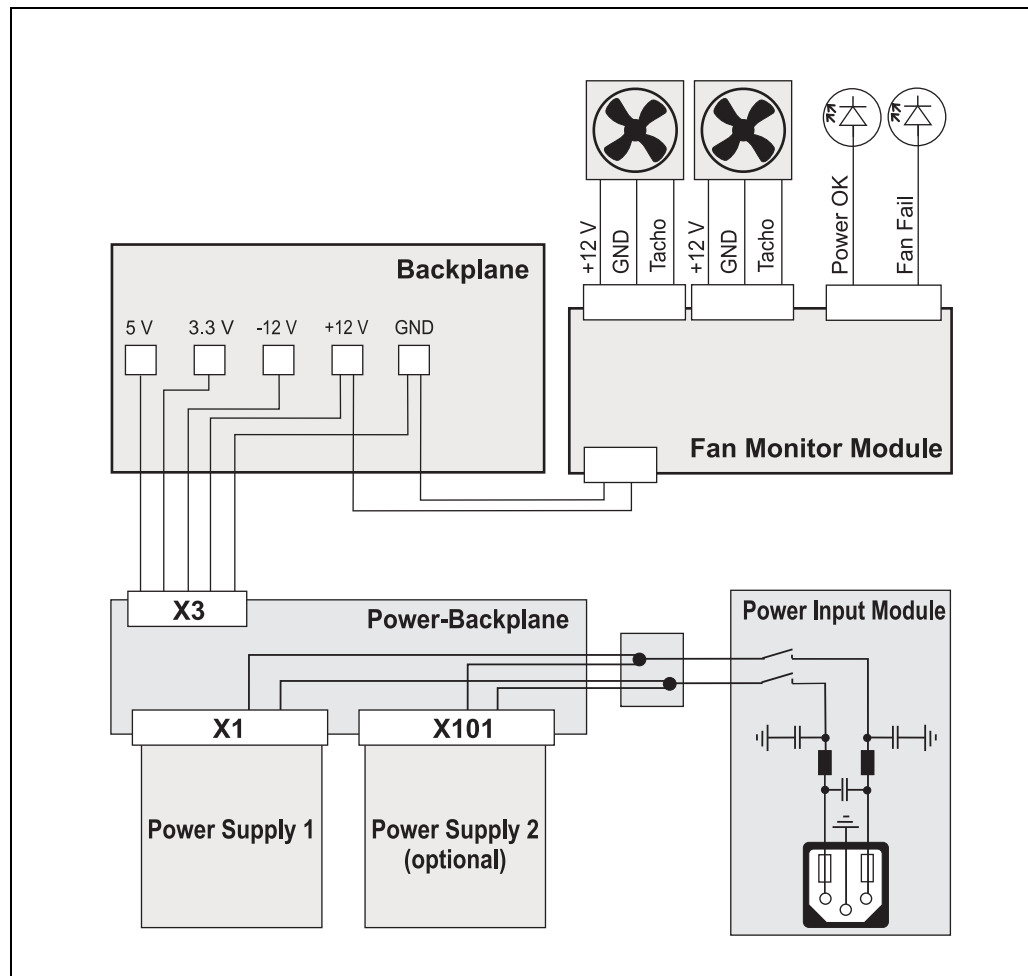

10009834

2.5 Cooling

Figure 5: Fan Tray



10009831

1 Power LED

2 Fan Fail LED

The boards and the power supply are cooled by forced air convection through two 80 mm 12 VDC axial fans (69 m³/h (40 cfm) each).

The fans and a Fan Monitor Module (FMM) are located on a hot-pluggable Fan Tray.

The fan speed is monitored by the Fan Monitor Module (FMM). When the fan speed drops 20% below nominal fan speed, the FMM will signal a fault condition with the red Fan Fail LED.



Caution!

To maintain proper airflow, all open slots must be covered with filler panels. The filler panel should include an airflow baffle that extends to backplane.

Figure 6: Airflow

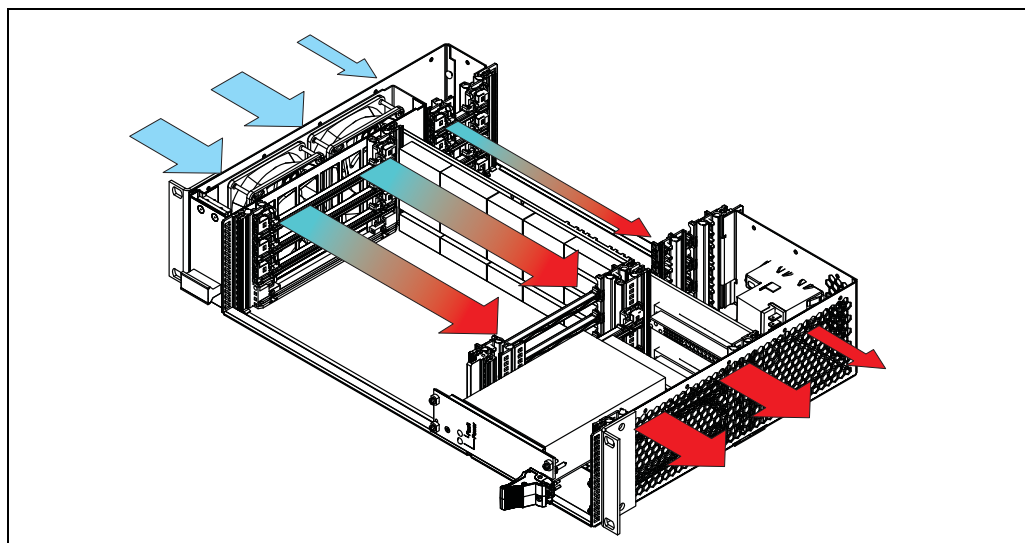

10009830

3 Assembly

3.1 General Assembly Guidelines

3.1.1 Unpacking



Caution!

When opening the shipping carton, use caution to avoid damaging the system.

Consider the following when unpacking and storing the system:

- Leave the system packed until it is needed for immediate installation.
- After unpacking the system, save and store the packaging material in case the system must be returned.

If the packaging is damaged and possible system damage is present, report to the shipper and analyze the damage.

3.1.2 Ensuring Proper Airflow

- Install the system in an open rack whenever possible. If installation in an enclosed rack is unavoidable, ensure that the rack has adequate ventilation.
- Maintain ambient airflow to ensure normal operation. If the airflow is blocked or restricted, or if the intake air is too warm, an over temperature condition can occur.
- Ensure that cables from other equipment do not obstruct the airflow through the systems.
- Use filler panels to cover all empty chassis slots. The filler panel prevents fan air from escaping out of the front of an open slot.



Caution!

To maintain proper airflow, all open slots must be covered with filler panels. The filler panel should include an airflow baffle that extends to backplane.

3.2 Rack-Mounting

This subrack system can be installed in 19" equipment racks. The rack must be accessible from the front and rear for equipment installation.

Mounting Instructions:

- Ensure that the rack is constructed to support the weight and dimensions of the system.
- Install any stabilizers that came with your equipment rack before mounting or servicing the system in the rack.
- Load the rack from the bottom to the top, with the heaviest system at the bottom, avoid uneven mechanical loading of the rack.

Tabelle 2: Commissioning

	<p>Warning!</p> <p><i>Voltages over 60 VDC can be present in this equipment. This equipment is intended to be accessed, to be installed and maintained by qualified and trained service personnel only.</i></p> <p><i>This equipment is designed in accordance with protection class 1!</i></p> <p><i>It must therefore be operated only with protective GND/earth connection!</i></p>
---	---

Before the commissioning of the system the following tasks have to be carried out:

- Ensure that the system has not been damaged during transport, storage or assembly.
- Carry out a new test for the protective earth – set value < 0.1 Ohm
- Switch on the system and check all VME64x voltages directly on the backplane before the board assembly.
- Plug-in the boards
- Cover the vacant slots with air flow barriers
- Power-on the system and measure the total input current
- Swap the fuses at the power input module with fuses that correspond to the value of the total input current.



Maximum fuse value is 8 A slow blow.

4 Service

4.1 Technical support and Return for Service Assistance

We generally recommend to return the complete subrack system. For all product returns and support issues, please contact your Schroff sales distributor or www.schroff.biz.

We recommend that you save the packing material. Shipping without the original packing material might void the warranty.

4.2 Declaration of Conformity

VME64x systems are not an end product. In order to make them operational, further assemblies are necessary.

In accordance with the definition in the EMC directives it is not classified as equipment, therefore a CE certification is not required. The systems do, however, fulfil all requirements in a full assembled state to the standard of EMC guideline 89/336/EWG and the low voltage guideline 73/23/EWG. Generally the systems are equipped with power supplies, which have a CE certification (EN 60950, EN 61000-6-3, EN 61000-6-2).

The selection of the filter elements is carried out with consideration of the hysteresis curve to EN 55022, class B. Interference resistance is guaranteed in accordance with EN 61000-6-2. Shielding measurements in the frequency area of 30 MHz to 1000 MHz to VG directive 95 373, Part 15, are carried out.

The systems were developed and manufactured in accordance with EN 60950. Before delivery each systems undergoes a voltage, protective earth and functionality test.

4.3 Delivery comprises

Quantity	Description
1	19" subrack, shielded, black powder coated (RAL9005)
1	VME64x backplane (VITA 1.1-1997), 4 slot 6 U with P0 connectors
1	Power backplane with two P47 connectors acc. PICMG 2.11
1	Front card cage for max. 4 boards 6 U 160 mm deep IEEE guide rails inc. ESD clips (ESD clip assembled at the right)
1	Rear card cage for max. 4 boards 6 U 80 mm deep IEEE guide rails inc. ESD clips
2	Slots for 2 plug-in power supplies
1	Complete AC/DC cabling
1	Power input module with IEC 320-C14 connector, mains/line switch, mains/line filter and fuses
1	Fan Tray, hot swappable
1	Front panel 3 U / 8 HP

4.4 Accessories

Order No.	Description
13100-141	250 W plug-in power supply with wide range input
20848-7xx	Slot covers with front panel and EMC shielding for vacant slots. For dimensions, please see catalogue.
34562-8xx	Slot covers for vacant slots. For dimensions, please see catalogue.

4.5 Replacement Parts

On request.

5 Technical Data

Table 3: Technical Data

Dimensions	
Height	88.10 mm (2 U)
Width	482.80 mm (19")
Depth (Card cage)	277.5 mm
Depth (Overall with handles)	312 mm
Weight	
Completely assembled	6 kg
Power Supply	
	(order separately)
Input Voltage	100 VAC bis 240 VAC
Frequency	50 / 60 Hz
Power input	up to 500 W
Cooling	
2 x 12 VDC fans	69 m ³ /h (40 cfm) each, free blow
Ambient Temperature	
Operation	+0 °C to +50 °C
Storage	-40 °C to +85 °C
Humidity	
Admissible humidity	30 % to 80 %, non-condensing
EMC, fulfils requirements for:	
Transient Emissions	EN 61000-6-3
Interference Resistance	EN 61000-6-2
Safety	
Test voltages according to EN 60950	Input - Output: 4,3 kVDC Input - PE: 2,2 kVDC Output - PE: 0,7 kVDC Output - Output: 0,7 kVDC
Shock and vibration:	EN 60068-2-6 and EN 60068-2-27
Electromagnetic Shielding	
Shielding attenuation	typ. 40 dB at 1 GHz if shielded front panels are used.

6 Dimensions

Figure 7: Dimensions

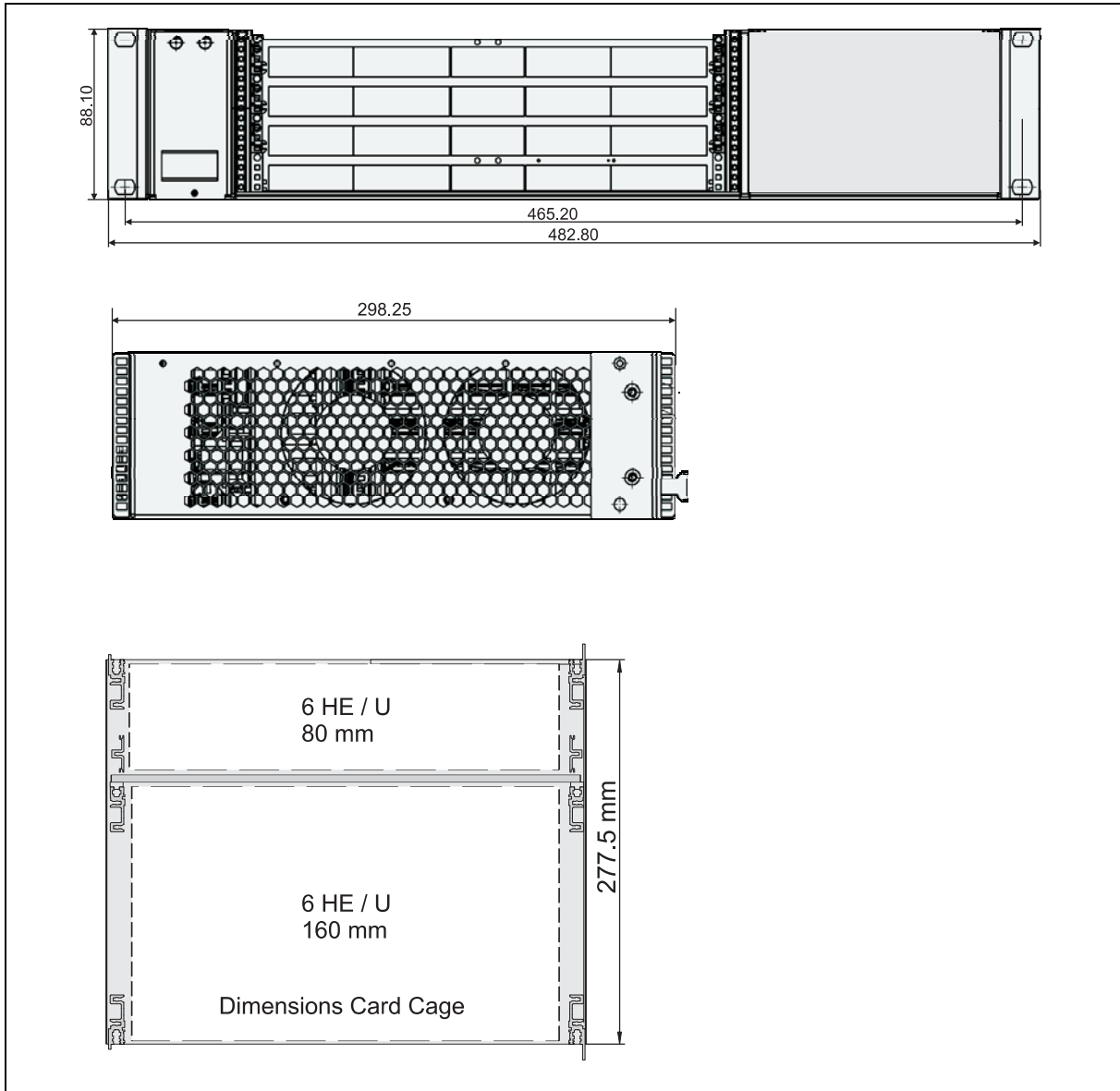



SCHROFF GMBH

**Langenalberstr. 96-100
D-75334 Straubenhardt**

www.schroff.biz

Tel.: + 49 (0) 7082 794-0

Fax: +49 (0) 7082 794-200