



# PA | PAC | PAD series

## piston pumps

fixed displacement in-line design

### ADVANTAGES

- ▶ *Of unique design, the PA, PAC and PAD pumps offer a robust solution with **long service life** for high pressure requirements in truck hydraulics.*
- ▶ *Relatively insensitive to contamination, these pumps are particularly **well suited to the harshest environments**.*
- ▶ *The design means the pumps can rotate either clockwise or counter-clockwise **without any user intervention**.*
- ▶ *Like all truck pumps designed by HYDRO LEDUC, this range is fitted with the **latest innovation in terms of sealing**:*
  - *Front of pump fitted with two shaft seals: externally, a seal capable of resisting the high temperatures of the gearbox, and internally, a seal adapted to the hydraulic requirements.*
  - *A transparent flexible tube fitted between the two seals, to protect these seals from dirt from the road, and from high pressure water jet during washing of vehicle etc...*



The PA, PAC, PAD pump series comprises three ranges, all designed for truck applications at working pressures up to 5800 psi (400 bar) continuous and 7252 psi (500 bar) peak.



## ► PA pumps

- single flow from 25 to 114 cc/rev
- twin-flow from 2x50 to 2x75 cc/rev
- two different flows: 75 - 40 cc/rev

## ► PAC pumps

Series offering the most compact size envelope:

- single flow from 40 to 80 cc/rev
- twin-flow from 2x25 to 2x40 cc/rev



## ► PAD pumps

Two-flow pumps, with 10 pistons, thus offering optimal flow regularity within reduced size envelope:

- twin-flow: 2x55 and 2x67 cc/rev

# PA | PAC | PAD - Dimensions

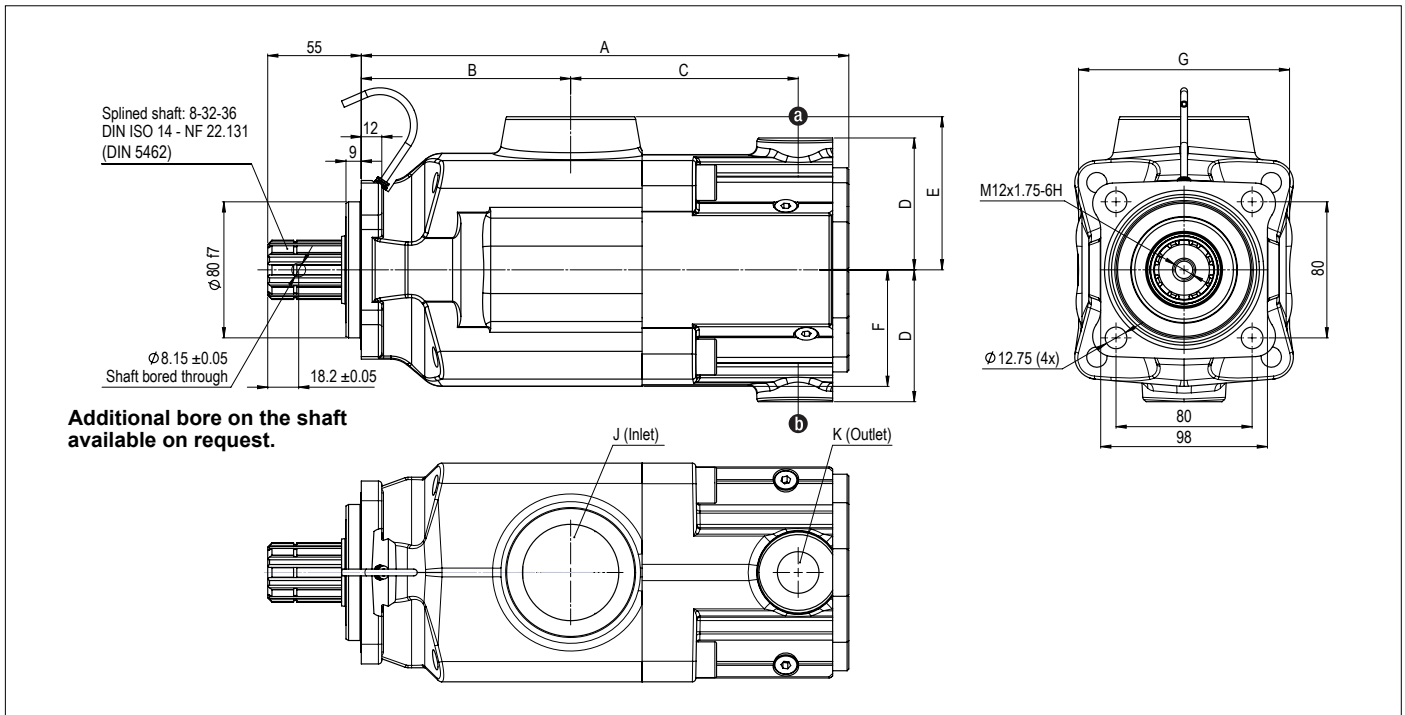

Pump reference	Displacement (cc/rev)		A	B	C	D	E	F	G	J	K	Weight (kg)	Overhang torque (N.m)	Max. speed (rpm)	Max. torque absorbed at 400 bar <sup>(1)</sup> (N.m)
	a	b													

## ► Single flow

PA 25	0511510	25	-	261	102	126	47	78	64	107	G 1 1/2"	G 3/4"	15	17	2200	177
PA 32	0511515	34	-	261	102	126	47	78	64	107	G 1 1/2"	G 3/4"	15	17	2000	240
PA 40	0511520	43	-	261	102	126	47	78	64	107	G 1 1/2"	G 3/4"	15	17	1750	304
PA 50	0511525	50	-	261	102	126	47	78	64	107	G 1 1/2"	G 3/4"	15	17	1650	354
PA 100	0511565	104	-	290	123	138.8	69	90	69	124	G 2"	G 3/4"	23.5	31.5	1400	736
PA 114	0511570	114	-	290	123	138.8	69	90	69	124	G 2"	G 3/4"	23.5	31.5	1350	807

PAC 40	0511460	40	-	226	94.9	103.3	62	73.2	54	98	G 1 1/2"	G 3/4"	12.5	12.6	1800	283
PAC 50	0511465	50	-	226	94.9	103.3	62	73.2	54	98	G 1 1/2"	G 3/4"	12.5	12.6	1650	354
PAC 65	0511490	65	-	243	102.5	112.8	63	78	65	107	G 1 1/2"	G 3/4"	16	17.6	1500	460
PAC 80	0511705	78	-	247	102.5	116.3	63	78	65	107	G 1 1/2"	G 3/4"	17	21.3	1350	552

## ► Twin-flow - 2 x 3 pistons

PA 2 x 50	0511555	52	52	290	123	138.8	69	90	69	124	G 2"	G 3/4"	23.5	31.5	1400	736 <sup>(2)</sup>
PA 2 x 57	0511560	57	57	290	123	138.8	69	90	69	124	G 2"	G 3/4"	23.5	31.5	1350	807 <sup>(2)</sup>
PA 2 x 75	0516100	75	75	302	126	147.8	72.5	90	72.5	135	G 2"	G 3/4"	26.8	38.7	1350	1062 <sup>(2)</sup>

PA 75-40	0516810	75	40	302	126	147.8	72.5	90	72.5	135	G 2"	G 3/4"	27.4	38.7	1350	807 <sup>(2)</sup>
----------	---------	----	----	-----	-----	-------	------	----	------	-----	------	--------	------	------	------	--------------------

PAC 2 x 25	0511480	25	25	243	102.5	112.8	63	78	65	107	G 1 1/2"	G 3/4"	16	17.6	1750	354 <sup>(2)</sup>
PAC 2 x 32	0511485	32	32	243	102.5	112.8	63	78	65	107	G 1 1/2"	G 3/4"	16	17.6	1500	460 <sup>(2)</sup>
PAC 2 x 40	0511710	39	39	247	102.5	116.3	63	78	65	107	G 1 1/2"	G 3/4"	17	21.3	1350	552 <sup>(2)</sup>

## ► Twin-flow - 2 x 5 pistons

PAD 2 x 55	0521210	55	55	287	123	133.8	77.5	90	69	124	G 2"	G 3/4"	24.6	34.4	1550	778 <sup>(2)</sup>
PAD 2 x 67	0518270	67	67	287	123	133.8	77.5	90	69	124	G 2"	G 3/4"	24.6	34.4	1400	948 <sup>(2)</sup>

(1) Maximum torque given with a mechanical efficiency at 90%.

(2) Maximum torque for the two pressure ports at 400 bar.

## ► Torque absorbed as a function of pump output pressure (with a mechanical efficiency considered at 90%)

### Single flow models

#### PA series

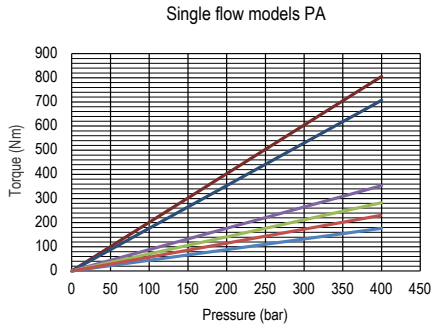

#### PAC series

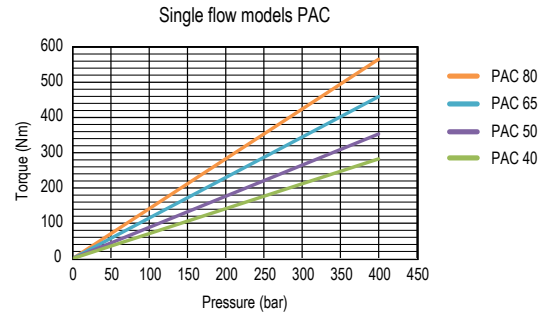

### Twin-flow models

#### PA series

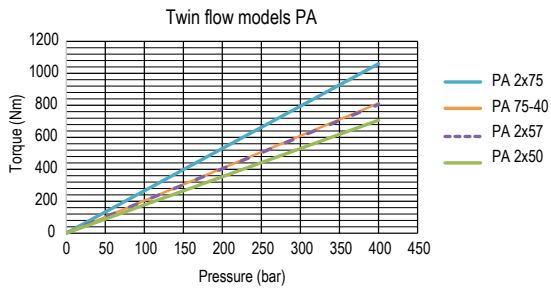

#### PAC series

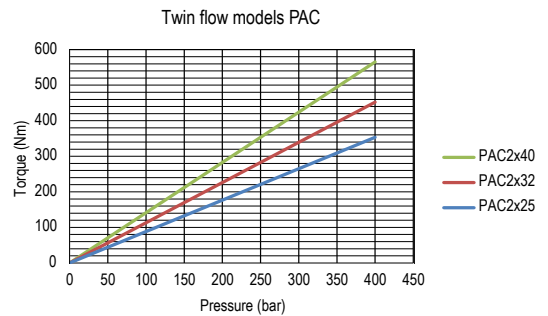

#### PAD series

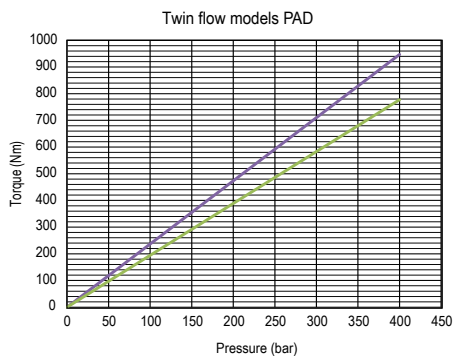

## ► Calculation of power to be supplied to the shaft as a function of flow and pressure

$$P = \frac{\Delta P \times Q}{600 \times \eta_{\text{global}}}$$

Calculation of torque to determine PTO, as a function of the displacement and the pressure

$$C = \frac{Cyl \times \Delta P}{62.8 \times \eta_{\text{meca}}}$$

- $P$  = Hydraulic power in kW
- $Q$  = Flow in l/min
- $\eta_{\text{global}}$  = Volumetric efficiency + mechanical efficiency
- $C$  = Torque in N.m
- $Cyl$  = Displacement in cc/rev
- $\Delta P$  = Differential pressure at the pump terminals, in bar
- $\eta_{\text{meca}}$  = Mechanical efficiency



## ► Flow as a function of rotating speed

### Single flow models

#### PA series

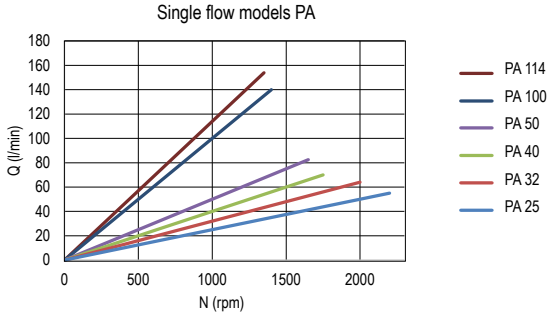

#### PAC series

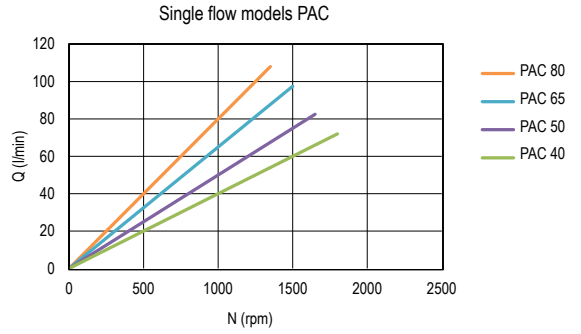

### Twin-flow models

#### PA series

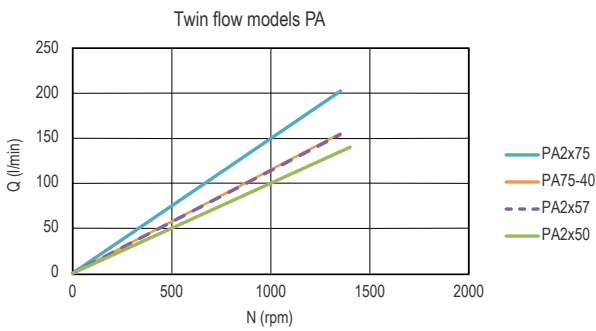

#### PAC series

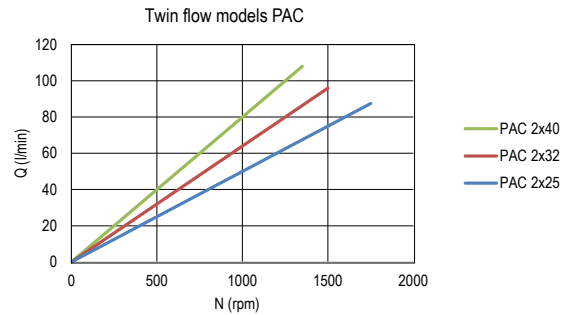

#### PAD series

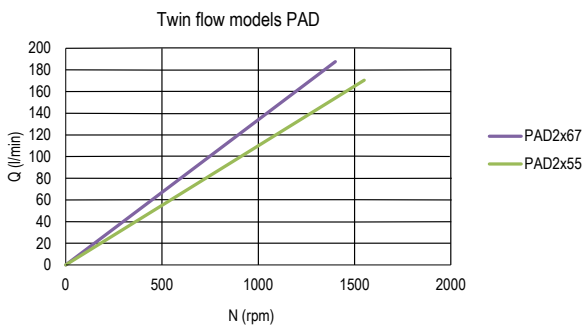

## ► Calculation of the flow

$$Q = \frac{\text{Cyl} \times N \times \eta_{\text{vol}}}{1000}$$

Avec :

- Q = Flow in l/min
- Cyl = Displacement in cc/rev
- N = Speed in rpm
- $\eta_{\text{vol}}$  = Volumetric efficiency

## ► Volumetric efficiency

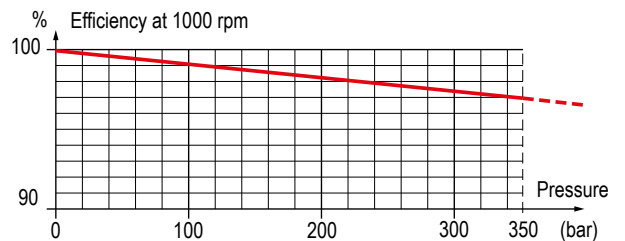

These graphs are the results of testwork done in HYDRO LEDUC R&D laboratory, on a specific test bench with a mineral hydraulic fluid ISO VG46 at 25°C (~100 cSt) - disregarding the volumetric efficiency.

## INLET FITTINGS FOR PA | PAC | PAD PUMPS

 **See recommendations of the hosing dimensions on page 42.**  
For high speeds, please consult.

### 90° elbow fittings, swivel

Reference	A	Ø B	C	D	E	F
240131	G 1 1/2"	40	60	17	61	77
240133	G 1 1/2"	50	60	17	65	82
240135	G 2"	50	70	17	65	82

Dimensions in mm.

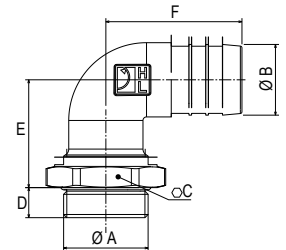

### Straight fittings

Reference	A	Ø B	C	D	E
240182	G 1 1/2"	40	56	14	54
240067	G 1 1/2"	50	52	14	66
240066	G 1 1/2"	60	64	14	69
240186	G 1 1/2"	63.5	64	14	69
240183	G 2"	50	66	14	54
240170	G 2"	60	66	14	72
240201	G 1 1/2"	76.2	80	14	89

Dimensions in mm.

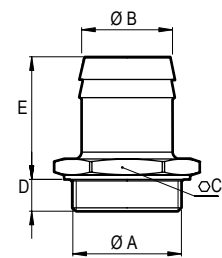

## DEFLECTOR TO PROTECT SHAFT SEALS

This deflector ensures the protection of the pump shaft seals.  
In particular, it protects the pump from projections of dirt from the road in cardan drive installations.

Reference: **DEF 054111**

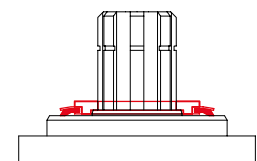

## CARDAN PLATE- DIN 90 and DIN 100

The cardan plate enables the pump shaft to be connected to a cardan shaft with interface as on drawing on the right.

Note: the maximum admissible torque is limited by the drive shaft.

Type	LEDUC code	ØA	ØB	C	D	E	F	ØG	H
<b>DIN 90</b>	<b>056315</b>	90	47	43	2	10	62	55	15
<b>DIN 100</b>	<b>0519040</b>	100	57	43	2	10	64	55	15

